

CS INSTRUMENTS

Proven and innovative
measuring technology
for compressed air
and gases

Chart recorder



Dew Point



Flow



Compressed air quality



Leakage



Software



Current



Pressure



Catalog 2019





DS 500



- Chart recorder for data logging of up to 4/8/12 sensors
- 7" Color display with touch panel
- Ethernet connection
- 4 GB Data memory

Page 8-11

DS 400



- Chart recorder for data logging of up to 2/4 sensors
- 3,5" Color display with touch panel
- Option: Ethernet connection
- Option: 4 GB Data memory

Page 12-15

DS 500 mobile



- Chart recorder for data logging of up to 4/8/12 sensors
- 7" Color display with touch panel
- In a sturdy case for the field use
- Ethernet connection
- 4 GB Data memory

Page 20-23

DS 400 mobile



- Chart recorder for data logging of up to 2/4 sensors
- 3,5" Color display with touch panel
- In a sturdy case for the field use
- Integrated Li-Ion battery
- Ethernet connection
- 4 GB Data memory

Page 24-27

PI 500



- Portable handheld device
- 1 sensor input
- 3,5" Color display with touch panel
- Integrated Li-Ion battery
- 4 GB Data memory

Page 28-29

Suitable sensors for DS 500 / DS 400

Page 16-18

Suitable sensors for mobile devices DS 500 / DS 400 / PI 500

Page 30-33



DP 500/510



- Mobile dew point device
- Meas. range $-80...+50^{\circ}\text{Ctd}$ pressure dew point
- 3,5" Color display with touch panel
- Integrated Li-Ion battery
- 4 GB Data memory

Page 38-39

DP 400 mobile



- Mobile dew point device in a sturdy case
- Integrated pressure measurement up to 16 bar
- Meas. range $-80...+50^{\circ}\text{Ctd}$ pressure dew point, ppm, atmospheric dew point, etc...
- Integrated Li-Ion battery

Page 40-41

FA 510/515



- Dew point sensor for measurement of residual moisture in compressed air and gases
- Meas. range $-80...+20^{\circ}\text{Ctd}$ or $-20...+50^{\circ}\text{Ctd}$
- 4...20 mA analogue output and/or Modbus-RTU

Page 42

DS 52



- Plug-in dew point set
- Meas. range: $-80...+20^{\circ}\text{Ctd}$ or $-20...+50^{\circ}\text{Ctd}$
- 2 Alarm relays (freely adjustable)
- 4...20 mA analogue output

Page 43



FA 515 EX



- Dew point sensor for residual moisture measurement in compressed air and gases in potentially explosive atmospheres
- Meas. range $-80...+20^{\circ}\text{Ctd}$
- Approvals: Zone 1: gas
Zone 2: dust
- 4...20 mA analog output

Page 44

FA 550



- Dew point sensor with a sturdy die-cast aluminum housing
- IP 67, suitable for outdoor use
- 2x 4...20 mA analogue output and other digital interfaces

Page 46-47

FA 500



- Dew point sensor with integrated display
- Meas. range: $-80...+20^{\circ}\text{Ctd}$ or $-20...+50^{\circ}\text{Ctd}$
- 4...20 mA analogue output and Modbus-RTU and other integrated interfaces

Page 48-49

DS 400



- Plug-in dew point set
- Option: integrated data logger dew point monitoring
- Option: Ethernet interface
- 3,5" Color display with touch panel

Page 50-51



VA 570

- Inline flow meter with flange
- Sturdy die-cast aluminum housing IP 67
- Option with ATEX or DVGW approval
- All wetted parts of stainless steel
- DN 15 to DN 80



Page 64-68

VA 570

- Inline flow meter with thread
- Sturdy die-cast aluminum housing IP 67
- Option with ATEX or DVGW approval
- All wetted parts of stainless steel
- 1/2" to 2"



Page 64-68

VA 550

- Sturdy flow meter as a insertion version
- Easy installation and removal under pressure without line interruption
- Applicable in existing pipes from 3/4" to DN 1000
- Option with ATEX or DVGW approval
- All wetted parts of stainless steel



Page 70-73

VA 500

- Flow meter as a insertion version
- Easy installation and removal under pressure without line interruption
- Applicable in existing pipes from 1/2" to DN 1000



Page 74-75

VA 520

- Inline flow meter with flange
- DN 15 to DN 80



Page 76-77

VA 520

- Inline flow meter with thread
- 1/4" to 2"



Page 78-79

VA 525

- Compact Inline flow meter
- No inlet section necessary – integrated flow straightener
- 1/4" to 2"



Page 80-81

**Accessories for Flow Measurement / Calibration /
Measuring ranges for different gases**

Page 82-86



Oil-Check 400 / PC 400 / FA 510



- Compressed air quality measurement according to ISO 8573
- Residual Oil - Particle – Moisture
- Stationary solution

Page 102-103

Oil-Check 400 / PC 400 / FA 510



- Compressed air quality measurement according to ISO 8573
- Residual Oil - Particle – Moisture
- Mobile solution

Page 103

Oil-Check 400 - stationary solution



- Monitoring system for residual oil content measurement in compressed air

Page 104-105

Oil-Check 400 - mobile solution



- Monitoring system for residual oil content measurement in compressed air
- With handle and stand plus flight case as an option

Page 105

PC 400/DS 400 - stationary solution



- Monitoring system for particle measurement in compressed air

Page 106-107

PC 400 / DS 500 mobile solution



- Monitoring system for particle measurement in compressed air
- PC 400 in a service case
- DS 500 mobile in a sturdy service case

Page 107

LD 500/510



- Leak detector with camera
- shows leakage rate in l/min and costs in Euro
- USB interface for data transfer into the evaluation software CS Leak Reporter
- Special accessories

Page 108-112

LD 400



- Low-price leak detector

Page 114-115

Int. Compressor Service

Company: Krapf + Lex
Project: Datenimport 2018-04-04T09:34:51.861Z

Report created at: 04.04.2018 11:52
from: Matthew Smith

Leakages

Project master data:
costBase: 19.00 €
costTime: 8760

Image	Building Place LeakTag	Date Time	Volume loss	Costs / Year	CO2 Tons / Year	Comment action measures Responsible	Status	Priority
	Neuer Gasteilweg 2 Flansch Nr. 3 - DN 15 003	04.04.2018 11:29:42	10.549 l/min	105.35 €	0.58	SEALING	🔴	
	Neuer Gasteilweg 2 Maschine 23 004	04.04.2018 11:31:19	21.528 l/min	214.99 €	1.19	Coupling	🔴	
	Neuer Gasteilweg 2 Maschine 23 005	04.04.2018 11:32:51	2.987 l/min	29.83 €	0.17	Piping	🔴	
			Σ 35.06 l/min	Σ 350.17 €	Σ 1.94		🔴	

CS Leak Reporter

- Creates a detailed ISO 50001 report
- Provides an illustrated overview of the leakages found and their savings potential

Page 111



CS Basic



- Data evaluation as a graph or in table form
- Reading the measurement data of all CS Instruments data loggers / paperless recorders via USB or Ethernet

Page 116-119

CS Network



- Energy monitoring software with Client/Server solution
- Automatically collects the measured values of all CS devices in the network on servers
- Evaluation / analysis at any number of workplaces (Client)

Page 120-121



DS 500 -

Intelligent chart recorder for compressed air and gases

Measurement - control - indication - alarm - recording - evaluation



Advantages at a glance:

- Clear layout: 7" color screen with touch panel...
- Versatile: Up to 12 optional sensors can be connected...
- Suitable for industrial applications: Metal housing IP 65 or panel mounting
- Data available through world wide web: Network-compatible and remote transmission via webserver
- Intelligent: Daily/weekly/monthly reports...
- Mathematical function for internal calculations
- Totalizer function for analogue signals
- ... Saves time and costs during installation

DS 500 - the intelligent chart recorder of the next generation

From recording of the measured data, indication on a big color screen, alerting, storage up to remote read-out via webserver... this is all possible with DS 500. By means of the webserver software alarms can be sent via SMS or e-mail.

All measured values, measured curves and threshold exceeding are indicated. The curve progressions from the beginning of the measurement can be viewed by an easy slide of the finger.

Daily/weekly/monthly reports with costs in € and counter reading in m³ for each consumption sensor are completing the sophisticated system concept. The big difference to ordinary paperless chart recorders reveals in the easy initiation and in the evaluation of the measured data. All sensors are identified directly and powered by DS 500. Everything is matched and tuned.

Mathematical function for internal calculations, e.g. the typical figures of a compressed air plant:

- costs in € per generated m³ air
- kWh/m³ generated air
- consumption of single lines including summation

Totalizer function for analogue signals (e.g. 0/4...20 mA, 0...10 V). In case of third-party sensors which e.g. only give a 4...20 mA signal for the actual flow in m³/h a total counter reading in m³ can be generated by means of the totalizer function.

No time consuming studying of the instruction manual... this saves time. Internal voltage supply of all sensors, no wiring of external mains units ... this saves additional costs.

Flow sensors for compressed air and gases

- Installation and removal under pressure via standard 1/2" ball valve
- A safety ring avoids the uncontrolled ejection in case of installation/removal under pressure
- Usable for different gases: compressed air, nitrogen, argon, CO₂, oxygen...



Dew point sensors

- Extremely long-term stable
- Quick adaption time
- Large measuring range (-80° to +20° Ctd)
- For all driers: Desiccant driers, membrane driers, refrigeration driers
- Easy installation under pressure via the standard measuring chamber with quick coupling



Pressure sensors

- Large selection of pressure sensors with different measuring ranges for each measuring purpose
- Quick installation under pressure by quick coupling
- Pressure sensors 0-10/16/40/100/250/400/600 bar overpressure
- Pressure sensors -1 - +15 bar (under-/overpressure)
- Differential pressure 0...1,6 bar
- Absolute pressure 0-1.6 bar (abs.)

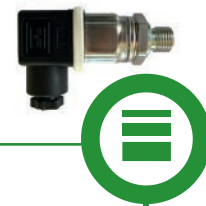

- Large selection of temperature sensors e.g. for measurement of the ambient temperature or gas temperature
- Pt100 (2-wire or 3-wire)
- Pt1000 (2-wire or 3-wire)
- KTY sensors
- Temperature sensors with measuring transducer (4-20 mA output)



Temperature sensors



- Monitoring the compressed air according to ISO 8773
- Residual oil, particle, residual moisture



Compressed air quality measurement



- CS ENERIUM 30 current/effective power meters for panel mounting with external current transformer for big machines and plants
- External current transformers for encompassing the phases (max. 2000 A)
- Measures KW, kWh, cos phi, kVar, kVA
- Data transfer DS 500 via Modbus



Current/effective power meters

By means of the intelligent chart recorder DS 500, all measuring data of a compressor station can be recorded, indicated and evaluated.

At 12 freely assignable sensor inputs all our sensors can be connected as well as any optional third-party sensors and meters with the following signal outputs:

4-20 mA, 0-20 mA I 0-1 V / 0-10 V / 0-30 V | Pt 100 (2- or 3-wire), Pt 1000 (2- or 3-wire), KTY | pulse outputs (e.g. of gas meters) frequency output | Modbus protocol.



Measured values, statistics, curves with the 7" color screen touch panel

A1 Compressed Air		A2 Compressed Air		A3 Compressed Air		A4 Compressed Air	
A1a	237.7 m ³ /h	A2a	729.702 m ³ /h	A3a	537.0 m ³ /h	A4a	254.7 m ³ /h
--	34106 m ³	--	13423271 m ³	--	155132 m ³	--	55234063 m ³
B1 Nitrogen		B2 Nitrogen		B3 Nitrogen		B4 Nitrogen	
B1a	337.7 ltr/min	B2a	657.7 ltr/min	B3a	15.7 ltr/min	B4a	237.7 ltr/min
--	27734 ltr	--	240041 ltr	--	34131 ltr	--	235322 ltr
C1 Oxygen		C2 Oxygen		C3 Oxygen		C4 Oxygen	
C1a	17.7 ltr/min	C2a	37.7 ltr/min	C3a	223.7 ltr/min	C4a	75.8 ltr/min
--	4080 ltr	--	234108 ltr	--	3749 ltr	--	43584 ltr

Zurück Virtuelle Kanäle Alarm Lp. stop days, Info... 24.03.2014
 Rp.run 16:41:52

Real time measured values

All measured values can be seen at a glance. Threshold exceeding are indicated in red color. A „measuring site name“ can be allocated to each sensor.

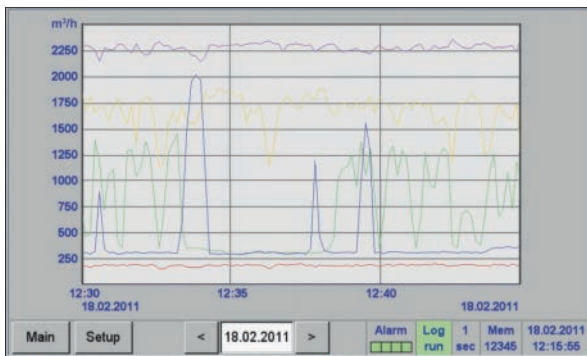

Graphic display

This display replaces the former evaluation of ordinary paper chart recorders and offers lots of advantages. The time axis can be moved by a finger slide. The „zoom function by finger movement“ which enables an analysis of peak values is unique.



Actual measurement values and graphic

Additionally to the measurement curves the real time value is indicated as well.

*** Consumption report ***

Month/Year	<A1> Hall 1.1 compressed air					Total
	Consumption per month m ³	Costs €	max value m ³ /h	min value m ³ /h	average m ³ /h	€
2010 May	7257	109	3.7	36.8	15.8	308
2010 June	9530	143	3.8	36.1	18.9	402
2010 July	7325	110	3.9	37.2	14.5	327
2010 August	8099	121	3.9	37.1	16.1	353
2010 September	7842	118	3.9	36.8	15.6	367
2010 October	6167	93	3.9	37.3	12.2	291
2010 November	9030	135	3.9	37.5	17.9	311
2010 December	9062	136	3.9	37.5	18.0	388
2010 Total	97953	1469	3.8	37.1	16.3	4164
2011 January	8880	133	3.5	37.7	17.6	412

Home Day/Week Week Month/Year

Statistics and reports

Different to ordinary chart recorders the DS 500 offers not only the recording of the measured data but also the evaluation of all flow sensors optionally as daily/weekly/monthly report at the push of a button.

It is no longer necessary to read-out the counter and transfer the values manually into a list. The reports can be imported to every PC into Excel® by means of a USB stick and after that they can be printed out without any additional software. This saves time and money and simplifies the evaluation enormously.

Technical data of the DS 500

TECHNICAL DATA DS 500	
Dimensions of housing:	280 x 170 x 90 mm, IP 65
Connections:	18 x PG 12 for sensors and supply
Version panel mounting:	Cutout panel 250 x 156 mm
Weight:	7.3 Kg
Material:	Die cast metal, front screen polyester
Sensor inputs:	<ul style="list-style-type: none"> • 4/8/12 sensor inputs for analogue and digital sensors freely allocatable. See options • Digital CS sensors for dew point and consumption with SDI interface FA/VA series, digital third-party sensors RS 485 / Modbus RTU, other bus systems realizable on request. • Analogue CS Sensors for pressure, temperature, clamp-on ammeters pre-configured. • Analogue third-party sensors 0/4...20 mA, 0...1/10/30V, pulse, Pt 100 / Pt 1000, KTY
Power supply for sensors:	24 VDC, max. 130 mA per sensor, integrated mains unit max. 24 VDC, 25 W. In case of version 8/12 sensor inputs, 2 integrated mains units each max. 24 VDC, 25 W.
Interfaces:	USB stick, Ethernet / RS 485 Modbus RTU / TCP, SDI other bus systems on request, WEB server optionally
Outputs:	<ul style="list-style-type: none"> • 4 relays (changeover contact 230 VAC, 6 A), alarm management, relays freely programmable, collective alarm • Analogue output, pulse in case of sensors with own signal output looped, like e.g. VA/FA series
Memory card:	Memory size 4 GB SD memory card standard
Power supply:	100...240 VAC / 50-60 Hz, special version 24 VDC
Color screen:	7" touch panel TFT transmissive, graphics, curves, statistics
Accuracy:	see sensor specifications
Operating temperature:	0...50°C
Storage temperature:	-20...70°C
Optionally:	Webserver
Optionally:	Option „energy and flow report“ statistics, daily/weekly/monthly report

DESCRIPTION	ORDER-NO.	INPUT SIGNALS
DS 500 - intelligent chart recorder in basic version (4 sensor inputs)	0500 5000	Current signal: (0...20mA/ 4...20mA) internal or external power supply Measuring range 0...20 mA Resolution 0.0001 mA Accuracy $\pm 0.03 \text{ mA} \pm 0.05 \%$ Input resistance 50 Ω Voltage signal: (0...1 V) Measuring range 0...1 V Resolution 0.05 mV Accuracy $\pm 0.2 \text{ mV} \pm 0.05 \%$ Input resistance 100 k Ω Voltage signal: (0...10 V / 30 V) Measuring range 0...10 V Resolution 0.5 mV Accuracy $\pm 2 \text{ mV} \pm 0.05 \%$ Input resistance 1 M Ω RTD Pt 100 Measuring range -200...850°C Resolution 0.1°C Accuracy $\pm 0.2^\circ\text{C}$ (-100...400°C) $\pm 0.3^\circ\text{C}$ (further range) RTD Pt 1000 Measuring range -200...850°C Resolution 0.1°C Accuracy $\pm 0.2^\circ\text{C}$ (-100...400°C) Pulse Measuring range min. pulse length 500 μs frequency 0...1 kHz max. 30 VDC
Option: 4 additional sensor inputs for DS 500	Z500 5001	
Option: 8 additional sensor inputs for DS 500	Z500 5002	
Option: Integrated webserver	Z500 5003	
Option: „energy and flow report“ statistics, daily/weekly/monthly report	Z500 5004	
Option: version for panel mounting	Z500 5006	
Option: power supply 24 VDC (instead of 100...240 VAC)	Z500 5007	
Option: „mathematics calculation function“ for 4 freely selectable „virtual“ channels, (mathematical functions: addition, subtraction, division, multiplication)	Z500 5008	
Option: „Totalizer function for analogue signals“	Z500 5009	
External Gateway Profibus	Z500 3008	
CS Basic – data evaluation graphically and in tabular form - reading of the measured data via USB or Ethernet, license for 2 workstations	0554 8040	
CS Network - Energy Monitoring with Client / Server Solution (Max. 20 measured values of different sensors / devices)	0554 8041	
CS Network - Energy Monitoring with Client / Server Solution (Max. 50 measured values of different sensors / devices)	0554 8042	
CS Network - Energy Monitoring with Client / Server Solution (Max. 100 measured values of different sensors / devices)	0554 8043	
CS Network - Energy Monitoring with Client / Server Solution (Max. 200 measured values of different sensors / devices)	0554 8044	

Matching sensors can be found on pages 16 to 18



DS 400 - Chart recorder

for all relevant parameters of compressed air



Standard equipment:

- USB interface
- 3.5" graphic display with touch screen
- Integrated mains unit for supply of the sensors
- 4...20 mA output of all connected active sensors
- Pulse output (for total consumption) in case of flow sensors
- 2 alarm relays (pot.-free switch-over contacts, max. 230 V, 3 A)







Software options:

- Integrated webserver
- Mathematics calculation function
- Totalizer function

Hardware options:

- Integrated data logger
- Ethernet / RS 485 interface
- additional sensor inputs (digital or analogue) selectable

The sensor inputs board 1 and 2 can be selected according to the required sensors (see table pages 16 to 18):

Digital	Digital	Digital	Digital	Analog	Analog	Analog	Analog
m ³ /h, m ³	°Ctd	A, kW/h		bar	A	°C	°C
							
Flow sensor	Dew point sensor	Current/effective power meter	Third-party sensors with RS 485	Pressure sensor	Clamp-on ammeter	Temperature sensor	Third party sensor analog output



Panel mounting

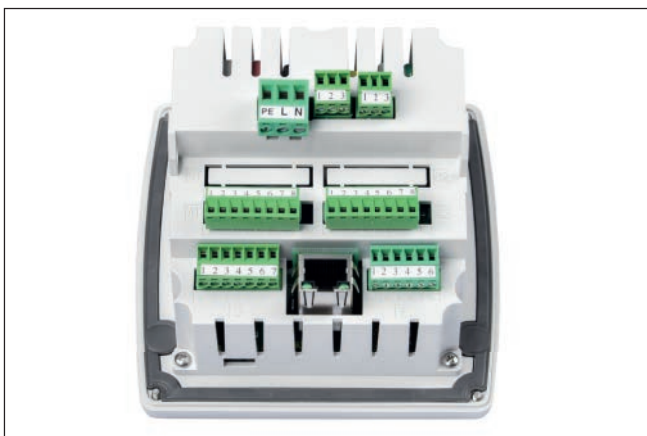

Back view

TECHNICAL DS 400	
Dimensions:	118 x 115 x 98 mm IP 54 (wall housing) 92 x 92 x 75 mm (panel mounting)
Inputs:	2 digital inputs for FA 5xx resp. VA 5xx
Interface:	USB
Power supply:	100...240 VAC, 50-60 Hz
Accuracy:	Please refer sensor specification
Alarm outputs:	2 relays, (pot.-free)
Options:	
Data logger:	100 million measuring values start/stop time, measuring rate freely adjustable
2 additional sensor inputs:	for connection of pres- sure sensors, tempera- ture sensors, clamp-on ammeters, third-party sensors with 4...20 mA, 0 to 10 V, Pt 100, Pt 1000

DESCRIPTION		ORDER-NO.
DS 400 - Mobile chart recorder with graphic display and touch screen	Sensor input 1+2	Sensor input 3+4
	Digital (Z500 4003)	-----
	Digital (Z500 4003)	Digital (Z500 4003)
	Digital (Z500 4003)	Analog (Z500 4001)
	Analog (Z500 4001)	-----
	Analog (Z500 4001)	Analog (Z500 4001)
Options:		
Option: Integrated data logger for 100 million measured values		Z500 4002
Option: Integrated Ethernet and RS 485 interface		Z500 4004
Option: Integrated webserver		Z500 4005
Option: „Mathematics calculation function“ for 4 freely selectable channels, (virtual channels): addition, subtraction, division, multiplication		Z500 4007
Option: „Totalizer function for analogue signals“		Z500 4006
External Gateway Profibus for RS 485 interface connection		Z500 3008
Future accessories:		
CS Basic – data evaluation graphically and in tabular form - reading of the measured data via USB or Ethernet, license for 2 workstations		0554 8040
CS Network - Energy Monitoring with Client / Server Solution (Max. 20 measured values of different sensors / devices)		0554 8041
CS Network - Energy Monitoring with Client / Server Solution (Max. 50 measured values of different sensors / devices)		0554 8042
CS Network - Energy Monitoring with Client / Server Solution (Max. 100 measured values of different sensors / devices)		0554 8043
CS Network - Energy Monitoring with Client / Server Solution (Max. 200 measured values of different sensors / devices)		0554 8044

INPUT SIGNALS	
Current signal	(0...20mA/4...20mA)
internal or external power supply	
Measuring range	0...20 mA
Resolution	0.0001 mA
Accuracy	± 0.03 mA ± 0.05 %
Input resistance	50 Ω
Voltage signal	(0...1 V)
Measuring range	0...1 V
Resolution	0.05 mV
Accuracy	± 0.2 mV ± 0.05 %
Input resistance	100 kΩ
Voltage signal	(0...10 V / 30 V)
Measuring range	0...10 V
Resolution	0.5 mV
Accuracy	± 2 mV ± 0.05 %
Input resistance	1 MΩ
RTD Pt 100	
Measuring range	-200...850°C
Resolution	0.1°C
Accuracy	± 0.2°C (-100...400°C) ± 0.3°C (further range)
RTD Pt 1000	
Measuring range	-200...850°C
Resolution	0.1°C
Accuracy	± 0.2° (-100...400°C)
Pulse	
Measuring range	minimum pulse length 500 μs frequency 0 ... 1 kHz, max. 30 VDC



DS 500 / DS 400

Easy operation via touch screen:

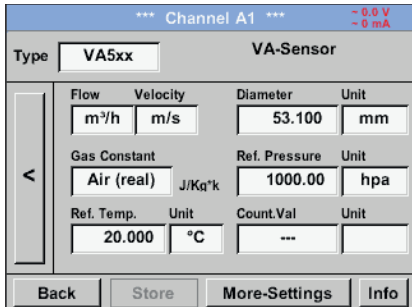

Configuration of flow sensor

In the menu of the DS 500 / DS 400, the flow sensor VA 5xx can be set to the respective pipe inside diameter. Furthermore, the unit, the gas type and the reference condition can be set. The meter reading can be set to „zero“ if necessary.



Graphic view

In the graphic view all measured values are indicated as curves. It is possible to browse back on the time axis by a slide of the finger (without data logger maximum 24 h, with data logger back to the start of the measurement).

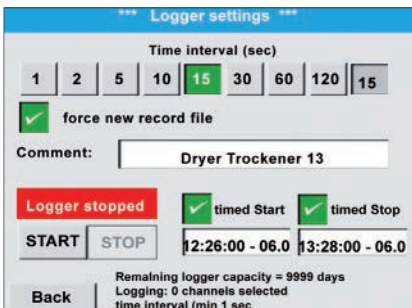

Data logger

With the option „integrated data logger“ the measured values are stored in the DS 500 / DS 400. The time interval can be determined freely. It is also possible to set the start time and end time of the data recording. Reading the measured data via USB interface or via the optional Ethernet interface.

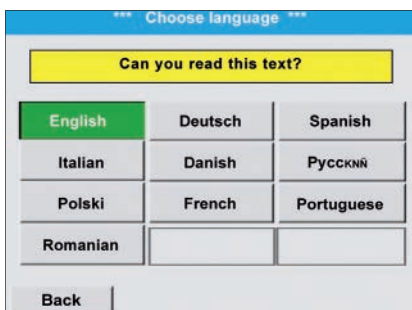

Selection of the language

Many languages are already stored in every DS 500/DS 400. The desired language can be selected via the selection button.

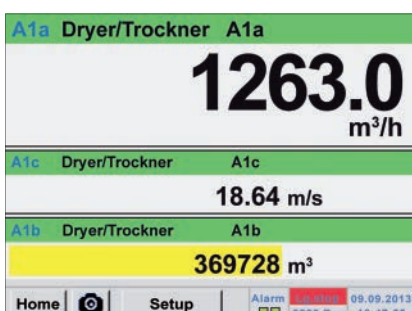

All relevant parameters at a glance

In addition to the flow rate in m³ / h, the DS 500 / DS 400 also displays other parameters such as total consumption in m³ and speed in m/s.

Webserver

The new webserver with extended features for the chart recorders DS 500 and DS 400 is available with immediate effect. Users can get direct access to their measured values worldwide (current and historic ones) and display them on their smart phone, tablet or computer. For monitoring of threshold values users can receive an automated „alarm E-mail“.

The new webserver can be ordered as an option with each stationary DS 500/400, but also for their mobile devices. For using the features of the webserver, the DS 500/400 must be set up with it's own IP address within the network.

The webserver provides a website, which displays the measuring values. This website can be accessed from any web browser on each smart phone, tablet or computer via it's unique IP address. This is all possible without the installation of any new or additional software.



View of the real time measured values (graphic table view)

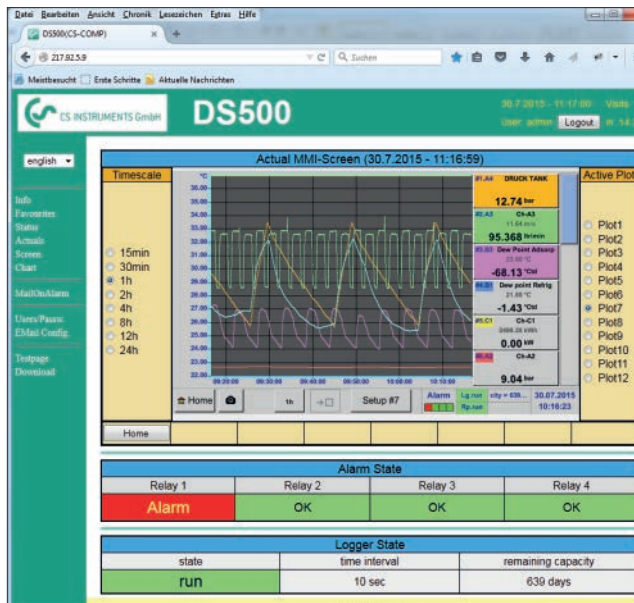

View of the historic measured values as a single chart (time period freely selectable)

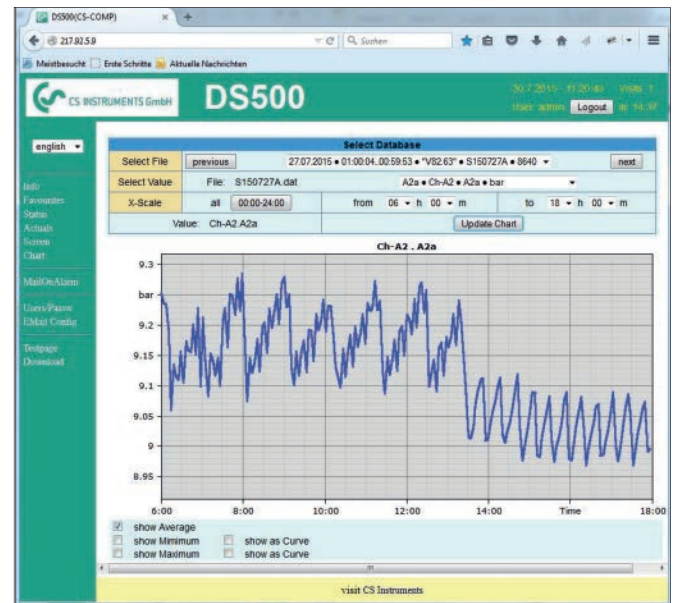

Automated „alarm e-mail“ for threshold value exceedance:

Access authorization

Different groups with different users/passwords can be assigned to different access levels.

Starting the data logger

In case of a stopped data logger the group operator or administrator can start the data logger remotely, via the web server.

PS: The new webserver can be retro fitted to any DS 500/ DS 400 already in use.



Suitable sensors for DS 500 / DS 400

Flow meters for installation and removal under pressure (insertion type)

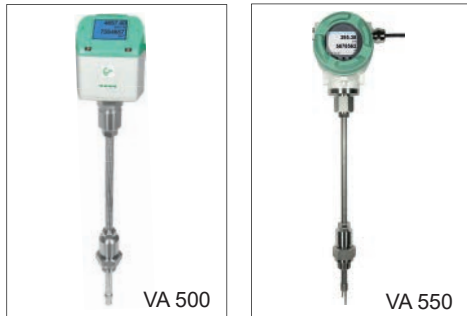

FLOW METERS INSERTION TYPE	ORDER-NO.
VA 500 meter in basic version: Standard (92,7 m/s), probe length 220 mm, without display	0695 5001
VA 550 Flow meter, measuring head in robuste aluminium die casting	0695 0550 + order code A_...M..._

Inline flow meter



FLOW METERS IN-LINE VERSION	ORDER-NO.
Flow meter VA 520 with integrated measuring section, (R 1/4" DN 8)	0695 0520
Flow meter VA 520 with integrated measuring section, (R 1/2" DN 15)	0695 0521
Flow meter VA 520 with integrated measuring section, (R 3/4" DN 20)	0695 0522
Flow meter VA 520 with integrated measuring section, (R 1" DN 25)	0695 0523
Flow meter VA 520 with integrated measuring section, (R 1 1/4" DN 32)	0695 0526
Flow meter VA 520 with integrated measuring section, (R 1 1/2" DN 40)	0695 0524
Flow meter VA 520 with integrated measuring section, (R 2" DN 50)	0695 0525



Flow-/ consumption meter VA 570 with integrated 1/2" measuring section	0695 0570 + order code A_...K_
Flow meter VA 570 with integrated 3/4" measuring section	0695 0571
Flow meter VA 570 with integrated 1" measuring section	0695 0572
Flow meter VA 570 with integrated 1 1/4" measuring section	0695 0573
Flow meter VA 570 with integrated 1 1/2" measuring section	0695 0574
Flow meter VA 570 with integrated 2" measuring section	0695 0575



DEW POINT SENSORS:	ORDER-NO.
FA 510 Dew point sensor, -80...+20 °Ctd incl. factory certificate	0699 0510
FA 510 Dew point sensor, -20...+50 °Ctd incl. factory certificate	0699 0512
Standard measuring chamber for compressed air up to 16 bar	0699 3390

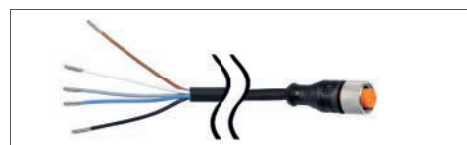

CONNECTION CABLE FOR CONSUMPTION METERS/ DEW POINT SENSORS VA 500, 520 AND FA 510:	ORDER-NO.
Connection cable for VA/FA series, 5 m	0553 0104
Connection cable for VA/FA series, 10 m	0553 0105

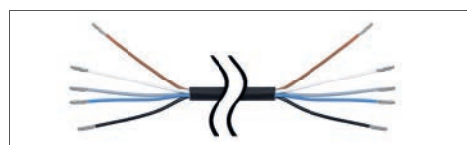

CONNECTION LINES FOR CONSUMPTION METERS VA 550/570:	ORDER-NO.
Connection cable 5 m with open ends	0553 0108
Connection cable 10 m with open ends	0553 0109



PRESSURE PROBES	± 1% ACCURACY	± 0,5% ACCURACY
Standard pressure probe CS 16, 0...16 bar	0694 1886	0694 3555
Standard pressure probe CS 40, 0...40 bar	0694 0356	0694 3930
Standard pressure probe CS 1.6, 0...1.6 bar		0694 3550
Standard pressure probe CS 10, 0...10 bar	0694 3556	0694 3554
Standard pressure probe CS 100, 0...100 bar		0694 3557
Standard pressure probe CS 250, 0...250 bar		0694 3558
Standard pressure probe CS 400, 0...400 bar		0694 3559
Precision pressure probe CS -1...+15 bar, ± 0.5% accuracy of f. s.		0694 3553
Differential pressure probe 1.6 bar diff.		0694 3561
Calibration certificate pressure, 5 calibration points for the whole measuring range		3200 0004



0604 0201

0604 0208



0604 0205



0554 0200

TEMPERATURE SENSORS	ORDER-NO.
Screw-in temperature sensor PT 100 class A, length 300 mm, d = 6 mm, with transmitter 4...20 mA = -50 °C...+ 500 °C (2-wire)	0604 0201
Outdoor temperature sensor PT 100 class B (2-wire) in panel mounting (82x55x33 mm) Application range: -50 °C...+80 °C	0604 0203
Indoor temperature sensor PT 100 class B (2-wire) in panel mounting with ventilation slots (82x55x33 mm), application range: -50 °C...+80 °C	0604 0204
Cable temperature sensor PT 100 class A (4-wire), length: 300 mm, d = 6 mm, -70 ... + 260 °C, 5 m connecting cable PFA with open ends	0604 0205
Cable temperature sensor PT 100 class A (4-wire), length: 100 mm, d = 6 mm, -70 ... + 260 °C, 5 m connecting cable PFA with open ends	0604 0206
Cable temperature sensor PT 100 class A (4-wire), length: 200 mm, d = 6 mm, -70 ... + 260 °C, 5 m connecting cable PFA with open ends	0604 0207
Magnetic surface temperature sensor, magnet 39x26x25 mm, PT 100 class B (2-wire), -30...+ 180 °C, 5m connection cable PFA with open ends	0604 0208
Compression fittings: 6mm; G 1/2" teflon clamping ring pressure-tight up to 10 bar. Material: stainless steel, application area: max. + 260 °C	0554 0200
Compression fittings: 6mm; G 1/2" teflon clamping ring pressure-tight up to 16 bar. Material: stainless steel, application area: max. + 260 °C	0554 0201
Calibration certificate temperature, 2 calibration points	0520 0180

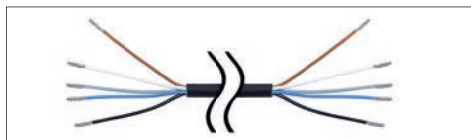

CONNECTION CABLES FOR PRESSURE PROBES/TEMP. SENSORS	ORDER-NO.
Connection cable for probes 5 m with open ends	0553 0108
Connection cable for probes 10 m with open ends	0553 0109

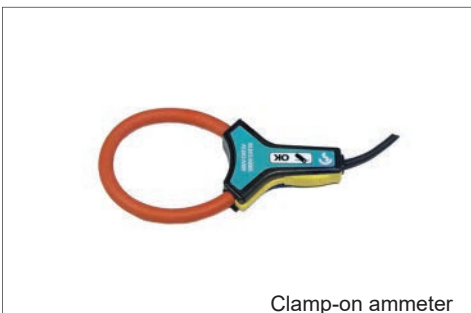

Clamp-on ammeter

CLAMP-ON AMMETERS	ORDER-NO.
Clamp-on ammeters 0 ... 1000 A TRMS incl. 3 m connection cable with open ends	0554 0518
Clamp-on ammeters 0 ... 400 A TRMS incl. 3 m connection cable with open ends	0554 0510



CS ENERIUM 30 - Current/ effective power meter for panel mounting

Measures voltage, current and calculates:

- Active power [kW]
- Apparent power [kVA]
- Reactive power [kVar]
- Active energy [kWh]
- cos phi

All measured data are transmitted digitally (Modbus) to the DS 500 and can be recorded there.

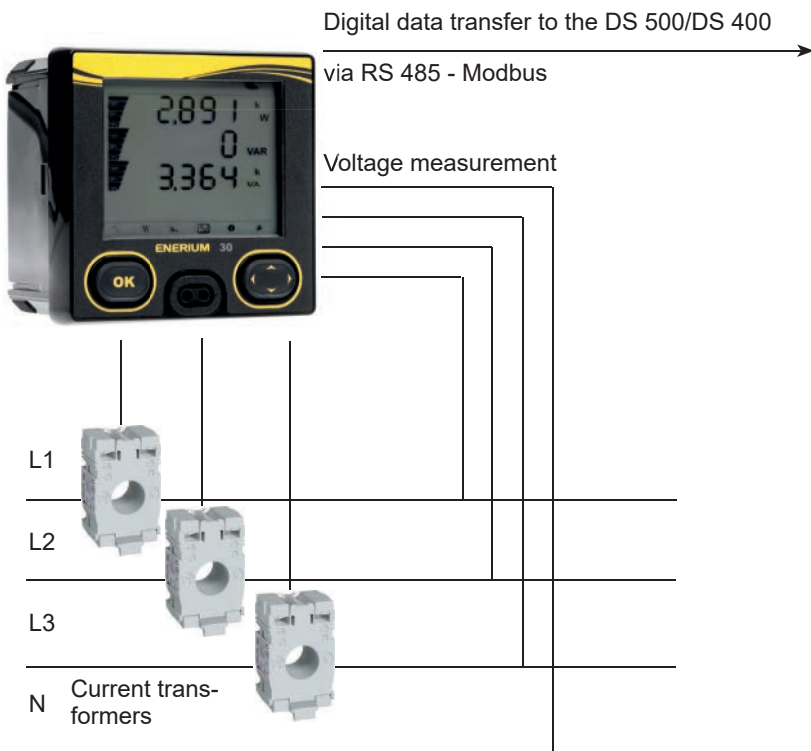

DESCRIPTION	ORDER-NO.
CS ENERIUM 30 current/effective power meter for panel mounting, with RS485 interface	0554 5355
Install-construction for the Enerium 30, on top hat rail	0554 5356
Current transformer 100/5 A connectable to current/effective power meter for panel mounting (for cables up to Ø 21 mm)	0554 5344
Current transformer 200/5 A connectable to current/effective power meter for panel mounting (for cables up to Ø 21 mm)	0554 5345
Current transformer 300/5 A connectable to current/effective power meter for panel mounting (for cables up to Ø 22 mm)	0554 5346
Current transformer 500/5 A connectable to current/effective power meter for panel mounting (for cables up to Ø 22 mm)	0554 5347
Current transformer 600/5 A connectable to current/effective power meter for panel mounting (for cables up to Ø 22 mm)	0554 5348
Current transformer 1000/5 A connectable to current/effective power meter for panel mounting (for current bar up to 65 x 32 mm)	0554 5349
Current transformer 2000/5 A connectable to current/effective power meter for panel mounting (for current bar up to 127 x 38 mm)	0554 5350
Connection cable for pressure, temperature or external sensors on mobile instruments, ODU / open ends, 5 m	0553 0108
Connection cable for pressure, temperature or external sensors on mobile instruments, ODU / open ends, 10 m	0553 0109

TECHNICAL DATA ENERIUM 30

Parameters:	Voltage (Volt) Current (Ampere) Cos phi Active power (kW) Apparent power (kVA) Reactive power (kVar) Active energy (kWh) Power frequency (Hz) All parameters are transferred digitally to DS 500/DS 400.
Accuracy current measurement:	± 0,5% of 1 to 6 A
Accuracy voltage:	± 0,5% of 50 V to 277 V
Accuracy active energy:	IEC 62053-21 Class 1
Interfaces:	RS 485 (Modbus protocol)
Measuring range:	Voltage measurement max. 480 Volt
Dimensions:	96 x 96 x 74 mm (B x H x T)
Operating temperature:	-10...+55°C



DS 500 mobil - intelligent mobile chart recorder

The intelligent mobile chart recorder - energy analysis according to DIN EN ISO 50001
Energy analysis - flow measurement - leakage calculation at compressed air systems

Your advantages at a glance:

- easy operation via 7" color display with touch panel

Versatile:

- Up to 12 sensors/meters connectable also third-party sensors/meters including power supply

Reliable:

- Stores all measured values on a memory card, easy reading-out via USB stick possible

Intelligent energy analysis:

- Daily / weekly / monthly evaluations mathematical functions for internal calculations e. g., the typical key figures of a compressed air system
 - Costs in € per generated m³ air
 - kWh/m³ generated air
 - Flow of single lines including summation



Easy & intuitive
in its operation

Saves time & costs
on installation

Technical data of DS 500 mobile

TECHNICAL DATA DS 500 MOBILE	
Case dimensions	360 x 270 x 150 mm
Weight:	4,5 kg
Material:	Diecast, front foil polyester, ABS
Sensor inputs:	4/8/12 sensor inputs for analogue and digital sensors; freely allocatable. (See options). Digital CS sensors for dew point and flow with SDI interface FA/VA series, digital third-party sensors RS485 / Modbus RTU. Analogue CS Sensors for pressure, temperature, clamp-on ammeters preconfigured. Analog third-party sensors 0/4...20 mA, 0...1/10/30V, pulse, Pt 100 / Pt 1000, KTY, counter
Voltage supply for sensor:	24 VDC, max. 130 mA per sensor, integrated mains unit, max. 24 VDC, 25 W. In case of version 8/12 sensor inputs 2 integrated mains unit, each max. 24 VDC, 25 W.
Interfaces:	USB stick, Ethernet / RS 485 Modbus RTU / TCP, SDI other bus systems on request, webserver optionally, GSM module
Memory card:	Memory size 4 GB SD Memory card
Voltage supply:	100...240 VAC / 50-60 Hz
Color display:	7" touch panel TFT transmissive graphics, curves statistics
Accuracy:	Please see sensor specifications
Operating temperature:	0...50°C
Storage temperature:	-20...70°C

INPUT SIGNALS	
Current signal internal or external power supply	(0...20mA/4...20mA)
Measuring range	0...20 mA
Resolution	0.0001 mA
Accuracy	± 0.03 mA ± 0.05 %
Input resistance	50 Ω
Voltage signal	
Measuring range	(0...1 V)
Resolution	0...1 V
Accuracy	0.05 mV
Input resistance	± 0.2 mV ± 0.05 % 100 kΩ
Voltage signal	
Measuring range	(0...10 V / 30 V)
Resolution	0...10 V
Accuracy	0.5 mV
Input resistance	± 2 mV ± 0.05 % 1 MΩ
RTD Pt 100	
Measuring range	-200...850°C
Resolution	0.1°C
Accuracy	± 0.2°C (-100...400°C) ± 0.3°C (further range)
RTD Pt 1000	
Measuring range	-200...850°C
Resolution	0.1°C
Accuracy	± 0.2° (-100...400°C)
Pulse	
Measuring range	Min. pulse length 100 µs frequency 0...1 kHz max. 30 VDC

DESCRIPTION	ORDER-NO.
Intelligent chart recorder DS 500 mobile, 4 sensor inputs	0500 5012
Intelligent chart recorder DS 500 mobile, 8 sensor inputs	0500 5013
Intelligent chart recorder DS 500 mobile, 12 sensor inputs	0500 5014
Option: „integrated webserver“	Z500 5003
Option: „energy and flow report“ statistics, daily/weekly/monthly report	Z500 5004
Option: „mathematics calculation function“ for 4 freely selectable „virtual“ channels, (mathematical functions: addition, subtraction, division, multiplication)	Z500 5008
Option: „Totalizer function for analogue signals“	Z500 5009
CS Basic – data evaluation graphically and in tabular form - reading of the measured data via USB or Ethernet, license for 2 workstations	0554 8040
CS Soft Energy Analyzer for energy and leakage analysis of compressed air stations	0554 7050
Connecting cable for pressure, temperature and external sensors to mobile devices, ODU/open ends, 5 m	0553 0501
Connecting cable for pressure, temperature and external sensors to mobile devices, ODU/open ends, 10 m	0553 0502
Connection cable for VA / FA sensors to mobile devices, ODU/M12, 5m	0553 1503
Extension cable for mobile devices, ODU/ODU, 10 m	0553 0504
Case for all sensors (dimensions: 500 x 360 x 120 x mm)	0554 6006

Further sensors can be found on pages 30 to 33



DS 500 mobil - intelligent mobile chart recorder

The intelligent chart recorder of the future - energy analysis according to DIN EN 50001

If we talk about operational costs of compressed air plants we are actually talking about the energy cost as they make up about 70 to 80 % of the total costs of a compressed air plant.

Depending on the size of the plant this means considerable operating costs. Even in smaller plants this may quickly add up to 10.000 to 20.000 € per year. This is an amount which can be considerably reduced - even in the case of well operated and maintained plants. Does this also apply to your compressed air plant? Which actual costs per generated m³ air do you actually have? Which energy is grind due to the waste heat recovery? What is the total performance balance of your plant? How high are the differential pressures of single filters, how high is the humidity (pressure dew point), how much compressed air is used?...

By means of the new intelligent chart recorder DS 500 mobile and the suitable sensors and meters all these questions can be answered easily. For example by means of a long-term measurement over 7 days, data recording and evaluation at the PC.



Touch screen



12 sensor inputs

Including voltage supply for all sensors



USB stick



Ethernet connection



Sensors for DS 500 / DS 400 mobile

Flow sensors for compressed air and gases

- Installation and removal under pressure via standard 1/2" ball valve
- A safety ring avoids the uncontrolled ejection in case of installation/removal under pressure
- Usable for different gases: compressed air, nitrogen, argon, CO₂, oxygen



Dew point sensor

- Extremely long-term stable
- Quick adaption time
- Large measuring range (-80° to +20° Ctd)
- For all driers: Desiccant driers, membrane driers, refrigeration driers
- Easy installation under pressure via the standard measuring chamber with quick coupling



Pressure sensors

- Large selection of pressure sensors with different measuring ranges for each measuring purpose
- Quick installation under pressure by quick coupling
- Pressure sensors 0-10/16/40/100/250/400/600 bar overpressure
- Pressure sensors -1 - +15 bar (under-/overpressure)
- Differential pressure 0...1,6 bar
- Absolute pressure 0-1.6 bar (abs:)



Temperature sensors

- Large selection of temperature sensors e.g. for measurement of the ambient temperature or gas temperature
- Pt100 (2-wire or 3-wire)
- Pt1000 (2-wire or 3-wire)
- Temperature sensors with measuring transducer (4-20 mA output)



- Monitoring of compressed air quality according to ISO 8773
- Residual oil, particles, residual moisture



Compressed air quality



- Particle counter PC 400 in the service case
- up to 0.1 µm or
- up to 0.3 µm



Compressed air quality

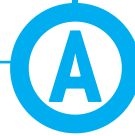

- For the analysis of compressors (load and idle times, energy consumption, on/off cycles) the current consumption of up to 12 compressors is recorded by current clamp
- Measuring range of the current clamps: 0 - 400 A
0 - 1000 A



Clamp-on ammeters

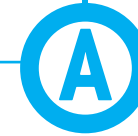

- CS PM 600 mobile current/active power meter with external current transformers for large machines and plants
- external current transformers for encompassing the phases (100 A or 600 A)
- external magnetic measuring tips for picking up the voltage
- measures KW, kWh, cos phi, kVar, kVA
- Data transmission DS 400 mobile via Modbus



Current/effective power meters

By means of the mobile chart recorder **DS 500 mobile**, all measuring data of a compressor station can be recorded, indicated and evaluated.

At **12 freely assignable sensor inputs** all our sensors can be connected as well as any optional **third-party sensors and meters with the following signal outputs:**

4-20 mA, 0-20 mA I 0-1 V / 0-10 V / 0-30 V I Pt 100 (2- or 3-wire), Pt 1000 (2- or 3-wire), KTY I pulse outputs (e.g. of gas meters) frequency output I Modbus protocol.



DS 400 mobil - affordable mobile chart recorder

Energy analysis - flow measurement - leakage calculation at compressed air systems

Advantages at a glance:

- easy operation via 3.5" color display with touch panel
- Internally rechargeable Li-Ion battery - about 8 hours continuous operation

Versatile:

- Up to 4 sensors / meters can be connected, including third-party sensors / counters incl. Power supply

Reliable:

- Stores all measured values on a memory card. Easy reading out via USB stick possible

Intelligent energy analysis:

- Daily / weekly / monthly evaluations mathematical functions for internal calculations e. g., the typical key figures of a compressed air system
 - Costs in € per generated m³ air
 - kWh/m³ generated air
 - Flow of single lines including summation



Up to 4 sensors can be connected including power supply for all sensors

Easy & intuitional
in its operation

Saves time & costs
on installation

Sensors for DS 500 / DS 400 mobile

Digital	Digital	Analog	Analog
<p>Flow meters for compressed air and gases</p> <ul style="list-style-type: none"> Installation and removal under pressure via standard 1/2" ball valve A safety ring avoids the uncontrolled ejection in case of installation/removal under pressure Usable for different gases: compressed air, nitrogen, argon, CO₂, oxygen  	<p>Dew point sensor</p> <ul style="list-style-type: none"> Extremely long-term stable Quick adaption time Large measuring range (-80° to +20° Ctd) For all driers: Desiccant driers, membrane driers, refrigeration driers Easy installation under pressure via the standard measuring chamber with quick coupling  	<p>Pressure sensors</p> <ul style="list-style-type: none"> Large selection of pressure sensors with different measuring ranges for each measuring purpose Quick installation under pressure by quick coupling Pressure sensors 0 - 10/16/40/100/250/400/600 bar overpressure Pressure sensors -1 - +15 bar (under-/overpressure) Differential pressure 0...1,6 bar Absolute pressure 0-1.6 bar (abs.)  	<p>Temperature sensors</p> <ul style="list-style-type: none"> Large selection of temperature sensors e.g. for measurement of the ambient temperature or gas temperature Pt100 (2-wire or 3-wire) Pt1000 (2-wire or 3-wire) Temperature sensors with measuring transducer (4-20 mA output)  
 <ul style="list-style-type: none"> Monitoring of compressed air quality according to ISO 8773 Residual oil, particles, residual moisture  <p>Compressed air quality</p>	 <ul style="list-style-type: none"> Particle counter PC 400 in the service case to 0.1 µm or up to 0.3 µm  <p>Compressed air quality</p>	 <ul style="list-style-type: none"> For the analysis of compressors (load and idle times, energy consumption, on/off cycles) the current consumption of up to 12 compressors is recorded by current clamp Measuring range of the current clamps: 0 - 400 A 0 - 1000 A  <p>Clamp-on ammeter</p>	 <ul style="list-style-type: none"> CS PM 600 mobile current/active power meter with external current transformers for large machines and plants external current transformers for encompassing the phases (100 A or 600 A) external magnetic measuring tips for picking up the voltage measures KW, kWh, cos phi, kVar, kVA Data transmission DS 500 mobile via Modbus  <p>Current/effective power meters</p>
Analog	Digital	Digital	Digital

By means of the chart recorder **DS 400 mobile**, all measured data of a compressor station can be recorded, indicated and evaluated. All digital sensors of our product range can be connected to the digital inputs.

Flow meter, dew point sensors, current/effective power meters and third-party sensors with Modbus RS 485 could be connected.

At **analog sensor inputs** third party sensors and meters with the following signal output could be connected: 4-20 mA, 0-20 mA | 0-1 V / 0-10 V / 0-30 V | Pt 100 (2- or 3-wire), Pt 1000 (2- or 3-wire), KTY | pulse outputs (e.g. of gas meters) | frequency output | Modbus protocol.

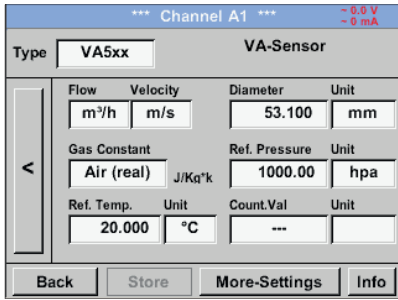

Configuration of flow sensor

In the menu of the DS 500 mobile/DS 400 mobile, the flow sensor VA 500 can be set to the respective pipe inside diameter. Furthermore, the unit, the gas type and the reference condition can be set. The meter reading can be set to „zero“ if necessary.

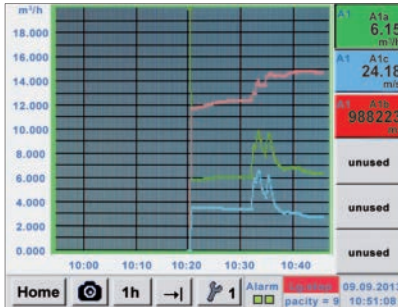

Graphic view

In the graphic view all measured values are indicated as curves. It is possible to browse back on the time axis by a slide of the finger (without data logger maximum 24 h, with data logger back to the start of the measurement).

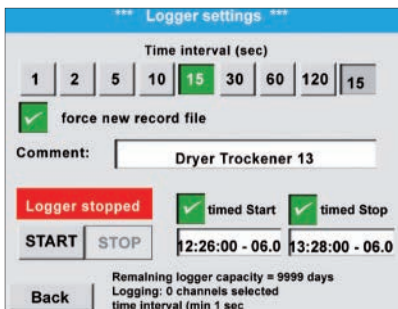

Data logger

With the option „integrated data logger“ the measured values are stored in the DS 500/DS 400. The time interval can be free determined. It is also possible to set the start time and end time of the data recording. Reading the measured data via USB interface or via the optional Ethernet interface.

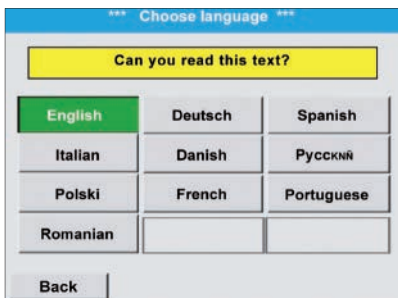

Selection of the language

Many languages are already stored in every DS 500 mobile/DS 400 mobile. The desired language can be selected via the selection button.

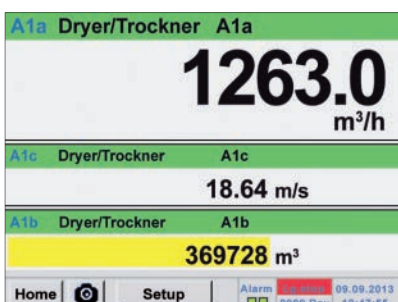

All relevant parameters at a glance





In addition to the flow rate in m³/h, the DS 500 mobile/DS 400 mobile also displays other parameters such as total consumption in m³ and speed in m/s.



Technical Data of DS 400 mobile

TECHNICAL DATA DS 400 MOBILE	
Dimensions:	270 x 225 x 156 mm (W x H x D)
Weight:	2.2 kg
Inputs:	2 x 2 sensor inputs for digital or analogue sensor signals
Interface:	USB (standard), Ethernet (optional)
Power supply:	Internal rechargeable Li-Ion batteries, approx 8 h continuous operation, 4 h charging time
Options:	
Integrated data logger:	100 million measuring values start/stop time, measuring rate freely adjustable
2 additional sensor inputs:	for connection of pressure sensors, temperature sensors, clamp-on ammeters, third-party sensors with 4...20 mA 0 to 10 V, Pt100, Pt1000

INPUT SIGNALS	
Current signals internal or external power supply	(0...20mA/4...20mA)
Measuring range	0...20 mA
Resolution	0.0001 mA
Accuracy	± 0.03 mA ± 0.05 %
Input resistance	50 Ω
Voltage signal:	(0...1 V)
Measuring range	0...1 V
Resolution	0.05 mV
Accuracy	± 0.2 mV ± 0.05 %
Input resistance	100 kΩ
Voltage signal	(0...10 V / 30 V)
Measuring range	0...10 V
Resolution	0.5 mV
Accuracy	± 2 mV ± 0.05 %
Input resistance	1 MΩ
RTD Pt 100	
Measuring range	-200...850°C
Resolution	0.1°C
Accuracy	± 0.2°C (-100...400°C) ± 0.3°C (further range)
RTD Pt 1000	
Measuring range	-200...850°C
Resolution	0.1°C
Accuracy	± 0.2° (-100...400°C)
Impuls	
Measuring range	Min pulse length 500 μs frequency 0...1 kHz max. 30 VDC

DESCRIPTION			ORDER-NO.
	Sensor input 1 and 2	Sensor input 3 and 4	
DS 400 - Mobile chart recorder with graphic display touch screen and integrated data logger	Digital (Z500 4003)	-----	0500 4012 D
	Digital (Z500 4003)	Digital (Z500 4003)	0500 4012 DD
	Digital (Z500 4003)	Analog (Z500 4001)	0500 4012 DA
	Analog (Z500 4001)	-----	0500 4012 A
	Analog (Z500 4001)	Analog (Z500 4001)	0500 4012 AA
Option:			
Option: Integrated Ethernet and RS 485 interface			Z500 4004
Option: Integrated webserver			Z500 4005
Option: „Mathematics calculation function“ for 4 freely selectable channels, (virtual channels): addition, subtraction, division, multiplication			Z500 4007
Option: „Totalizer function for analogue signals“			Z500 4006
Further accessories:			
CS Basic – data evaluation graphically and in tabular form - reading of the measured data via USB or Ethernet, license for 2 workstations			0554 8040
CS Soft Energy Analyzer for energy and leakage analysis of compressed air stations			0554 7050
Connecting cable for pressure, temperature and external sensors to mobile devices, ODU/open ends, 5 m			0553 0501
Connecting cable for pressure, temperature and external sensors to mobile devices, ODU/open ends, 10 m			0553 0502
Connection cable for VA / FA sensors to mobile devices, ODU/M12, 5m			0553 1503
Extension cable for mobile devices, ODU/ODU, 10 m			0553 0504
Connecting cable for mobile current / active power meter to mobile devices, length 5 m			0553 0506
Case for all sensors (dimensions: 500x360x120 mm)			0554 6006

Digital	Digital	Digital	Digital
m³/h, m³	°Ctd	A, kW/h	
			
Flow sensor	Dew point sensor	Current meter	Third-party with RS 485

Analog	Analog	Analog	Analog
bar	A	°C	°C
			4...20 mA 0...20 mA 0...10 V Pulse Pt 100 Pt 1000
Pressure sensor	Clamp-on ammeter	Temperature sensor	Thirdparty sensor analog output

Suitable sensors can be found on pages 30 to 33



PI 500 - Hand-held instrument for industry

The new PI 500 is an all-purpose hand-held measuring instrument for many applications in industry like e. g.:

- **Flow measurement**
- **Pressure/vacuum measurement**
- **Temperature measurement**
- **Moisture/dew point measurement**

The graphic indication of colored measurement curves is inimitably.

Up to 100 million measured values can be stored with date and name of measuring site. The measured values can be transferred to the computer by means of a USB stick. The data can be comfortably evaluated with the CS Basic software.

Measured data and service reports can be issued easily and quickly. The following sensors can be connected to the freely configurable sensor input of PI 500:

- Pressure sensors (high and low pressure)
- Flow sensors, VA 500/520
- Temperature sensors Pt 100, Pt 1000 / 4...20 mA
- Dew point sensors FA 510
- Effective power meters
- Optional third-party sensors with the following signals: 0...1/10 V, 0/4...20 mA, Pt 100, Pt 1000, pulse, Modbus



Special features:

- Universal sensor input for lots of common sensor signals
- Internal rechargeable Li-Ion batteries (approx. 12h continuous operation)
- 3.5" graphic display / easy operation via touch screen
- Integrated data logger for storage of the measured values
- USB interface for reading out via USB stick
- International: Up to 8 languages selectable

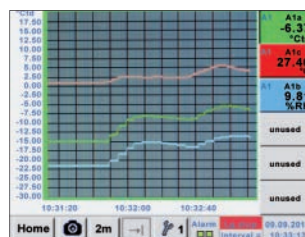

Measurement curves are indicated graphically and thus the user can see the behavior of the dryer at a glance since the start of the measurement.



All physical parameters of moisture measurement are calculated automatically.

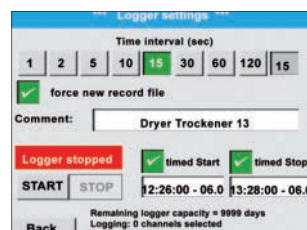

It is possible to store up to 100 million measured values. Each measurement can be stored with a comment, e.g. measuring site name. The time interval can be freely determined.

PI 500 - Hand-held instrument with large sensor selection

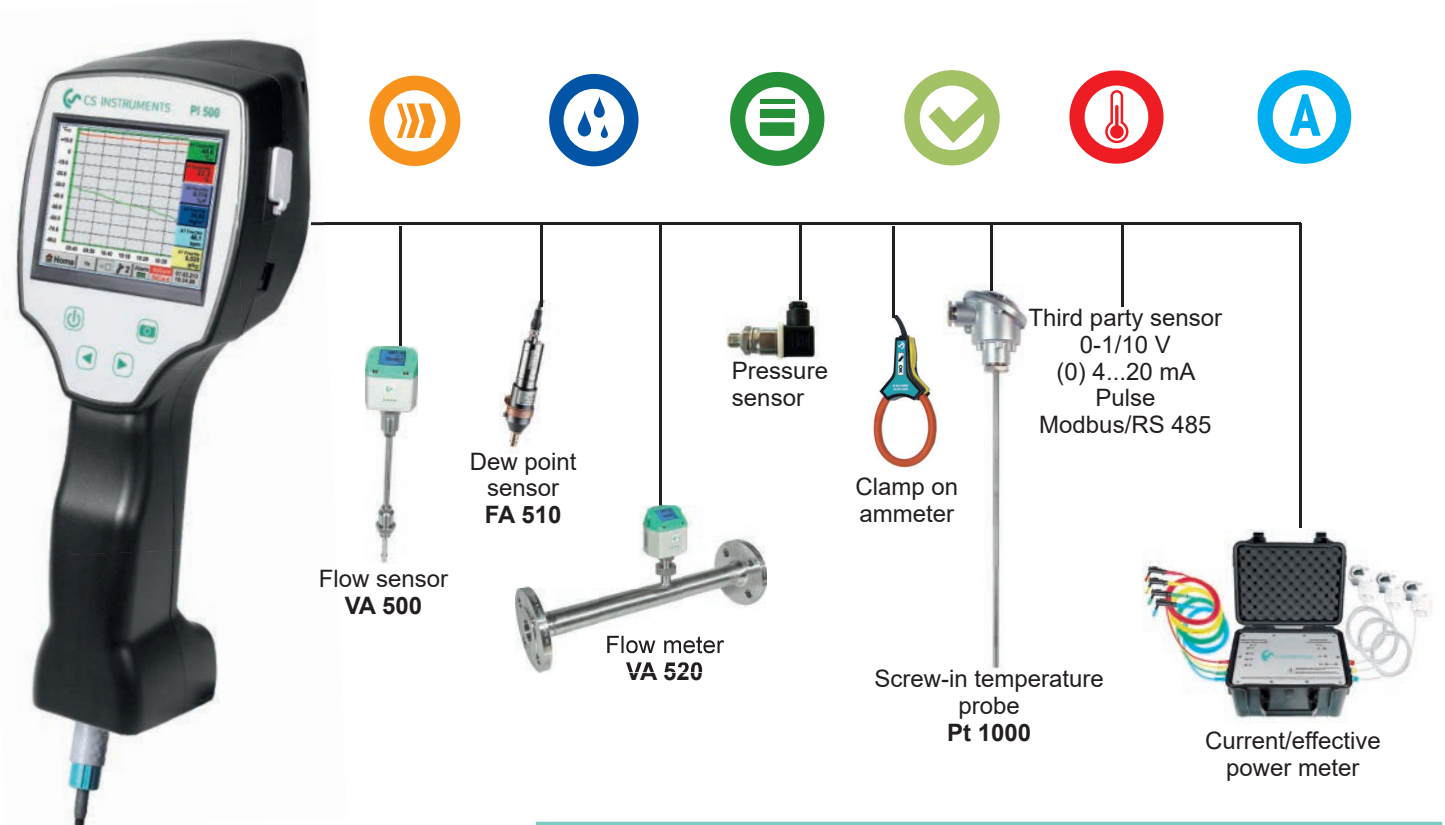

INPUT SIGNALS	
Current signals internal or external power supply	(0...20mA/4...20mA)
Measuring range	0...20 mA
Resolution	0.0001 mA
Accuracy	$\pm 0.03 \text{ mA} \pm 0.05 \%$
Input resistance	50 Ω
Voltage signal:	(0...1 V)
Measuring range	0...1 V
Resolution	0.05 mV
Accuracy	$\pm 0.2 \text{ mV} \pm 0.05 \%$
Input resistance	100 k Ω
Voltage signal	(0...10 V / 30 V)
Measuring range	0...10 V
Resolution	0.5 mV
Accuracy	$\pm 2 \text{ mV} \pm 0.05 \%$
Input resistance	1 M Ω
RTD Pt 100	
Measuring range	-200...850°C
Resolution	0.1°C
Accuracy	$\pm 0.2^\circ\text{C}$ (-100...400°C) $\pm 0.3^\circ\text{C}$ (further range)
RTD Pt 1000	
Measuring range	-200...850°C
Resolution	0.1°C
Accuracy	$\pm 0.2^\circ\text{C}$ (-100...400°C)
Impuls	
Measuring range	Min pulse length 500 μs frequency 0...1 kHz max. 30 VDC

DESCRIPTION	ORDER-NO.
PI500 portable measuring instrument with integrated data logger, incl. power supply	0560 0511
Option for PI 500: "mathematics calculation function" for 4 freely selectable „virtual" channels	Z500 5107
Option „Totalizer function for analogue signals"	Z500 5106
CS Basic – data evaluation graphically and in tabular form - reading of the measured data via USB or Ethernet, license for 2 workstations	0554 8040
Transport case	0554 6510

Further sensors can be found on pages 30 to 33

TECHNICAL DATA PI 500	
Display:	3.5" touchpanel TFT transmissive, graphics, curves, statistics
Interface:	USB interface
Power supply for sensors::	Output voltage: 24VDC $\pm 10\%$ Output current: 120 mA in continuous operation
Power supply:	Internal rechargeable Li-Ion batteries, charging time approx. 4 h, PI 500 continuous operation > 4h depending on power consumption for ext. sensor
Power adapter:	100 - 240 VAC / 50 - 60 Hz, 12 VDC - 1A, safety class 2 only for use in dry rooms
Dimensions:	82 x 96 x 245 mm
Housing material:	PC/ABS
Weight:	450 g
Operating temperature:	0...50°C Ambient temperature
Storage temperature:	-20 bis +70°C
EMC:	DIN EN 61326
Sensor input:	For connection of pressure and temperature sensors, current clamps, external sensors with 4 ... 20 mA, 0-10V, Pt 100, Pt 1000, Modbus
Memory Size:	8 GB - Memory card standard



Suitable sensors for DS 500 mobile, DS 400 mobile, PI 500, DP 510, LD 510

Flow meters for installation and removal under pressure (insertion-type)



VA 500



VA 550

CONSUMPTION METERS INSERTION-VERSION	ORDER-NO.
VA 500 flow meter, Max version (185 m/s), probe length 220 mm, incl. 5 m connection cable to mobile devices	0695 1124
VA 500 flow meter, High-Speed version (224 m/s), probe length 220 mm, incl. 5 m connection cable to mobile devices	0695 1125
VA 550 Flow meter, measuring head in robust aluminium die casting housing	0695 0550 + order code A...M..._

Inline flow meter



VA 520



VA 570



FA 510

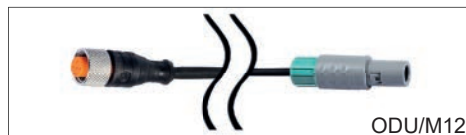

ODU/M12

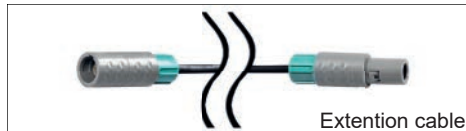

Extention cable



FLOW METERS INLINE VERSION	ORDER-NO.
Inline Flow meter VA 520 with integrated measuring section, (R 1/4" DN 8)	0695 0520
Inline Flow meter VA 520 with integrated measuring section, (R 1/2" DN 15)	0695 0521
Inline Flow meter VA 520 with integrated measuring section, (R 3/4" DN 20)	0695 0522
Inline Flow meter VA 520 with integrated measuring section, (R 1" DN 25)	0695 0523
Inline Flow meter VA 520 with integrated measuring section, (R 1 1/4" DN 32)	0695 0526
Inline Flow meter VA 520 with integrated measuring section, (R 1 1/2" DN 40)	0695 0524
Inline Flow meter VA 520 with integrated measuring section, (R 2" DN 50)	0695 0525
Inline Flow meter VA 570 with integrated 1/2" measuring section	0695 0570 + order code A...K_
Inline Flow meter VA 570 with integrated 3/4" measuring section	0695 0571
Inline Flow meter VA 570 with integrated 1" measuring section	0695 0572
Inline Flow meter VA 570 with integrated 1 1/4" measuring section	0695 0573
Inline Flow meter VA 570 with integrated 1 1/2" measuring section	0695 0574
Inline Flow meter VA 570 with integrated 2" measuring section	0695 0575

DEW POINT SENSORS	ORDER-NO.
FA 510 Dew point sensor, -80 ... + 20 ° Ctd incl. measuring chamber mobile and 5 m connection cable to mobile devices	0699 1510
FA 510 Dew point sensor, -20 ... + 50 ° Ctd incl. measuring chamber mobile and 5 m connection cable to mobile devices	0699 1512

CONNECTION CABLE FOR VA 500/520 AND FA 510 SENSORS	ORDER-NO.
Connection cable for VA / FA sensors to mobile devices, ODU/M12, 5 m	0553 1503
Extention cable for mobile für mobile equipment, 10 m	0553 0504

CALIBRATION CERTIFICATES FOR CONSUMPTIONS METERS AND DEW-POINT SENSORS	ORDER-NO.
5 point precision calibration for flow sensors incl. ISO certificate	3200 0001
Precision adjustment at -40 ° Ctd with ISO certificate	0699 3396

Suitable sensors for DS 500 mobile, DS 400 mobile, PI 500, DP 510, LD 510



PRESSURE PROBES	± 1% ACCURACY	± 0,5% ACCURACY
Standard pressure probe CS 16, 0...16 bar	0694 1886	0694 3555
Standard pressure probe CS 40, 0...40 bar	0694 0356	0694 3930
Standard pressure probe CS 1.6, 0. 1.6 bar abs.		0694 3550
Standard pressure probe CS 10, 0...10 bar	0694 3556	0694 3554
Standard pressure probe CS 100, 0...100 bar		0694 3557
Standard pressure probe CS 250, 0...250 bar		0694 3558
Standard pressure probe CS 400, 0...400 bar		0694 3559
Precision pressure probe CS -1...+15 bar, ± 0.5% accuracy of. f.s.		0694 3553
Differential pressure probe 1.6 bar diff.		0694 3561
Calibration certificate pressure, 5 calibration points for the whole measuring range	3200 0004	

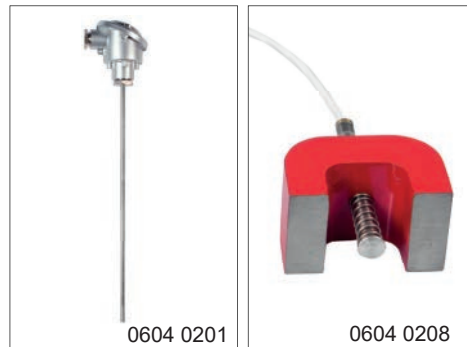

0604 0201

0604 0208

TEMPERATURE SENSORS	ORDER-NO.
Bendable temperature probe PT 100 (2-wire) class A, length: 300 mm, d=3 mm, -70°C to +500°C, connect cable PFA, 2 m with ODU-plug (8 pole) to mobile instruments	0604 0200
Screw-in temperature sensor PT 100 class A, length 300 mm, d = 6 mm, with transmitter 4...20 mA = -50 °C...+ 500 °C (2-wire)	0604 0201
Cross-band surface temperature probe, thermocouple Type K, with integrated transducer 4...20 mA = 0°C...+180°C, 2 m connect calbe (PVC) with ODU-plug (8-pole) to mobile instruments	0604 0202
Cable temperature sensor PT 100 class A (4-wire), length: 300 mm, d = 6 mm, -70 ... + 260 ° C, 5 m connect cable PFA with open ends	0604 0205
Cable temperature sensor PT 100 class A (4-wire), length: 100 mm, d = 6 mm, -70 ... + 260 ° C, 5 m connection cable PFA with open ends	0604 0206
Cable temperature sensor PT 100 class A (4-wire), length: 200 mm, d = 6 mm, -70 ... + 260 ° C, 5 m connect cable PFA with open ends	0604 0207
Magnetic surface temperature sensor, magnet 39x26x25 mm, PT 100 class B (2-wire), -30...+ 180 °C, 5m connection cable PFA with open ends	0604 0208
Compression fittings: 6mm; G 1/2" teflon clamping ring pressure-tight up to 10 bar. Material: stainless steel, application area: max. + 260 °C	0554 0200
Compression fittings: 6mm; G 1/2" teflon clamping ring pressure-tight up to 16 bar. Material: stainless steel, application area: max. + 260 °C	0554 0201
Calibration certificate temperature, 2 calibration points	0520 0180



0604 0205



0554 0200

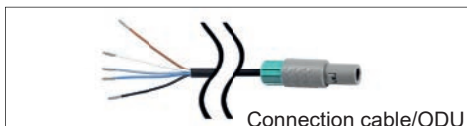

Connection cable/ODU

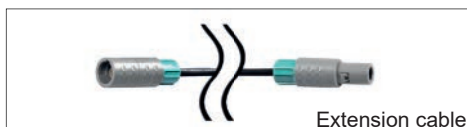

Extension cable

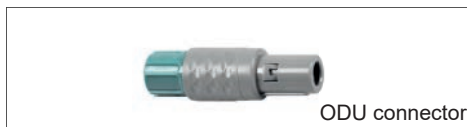

ODU connector

CONNECTION CABLES FOR PRESSURE SENSORS / TEMPERATURE SENSORS:	ORDER-NO.
Connection cable for pressure, temperature and external sensors to mobile devices, ODU/open ends, 5 m	0553 0501
Connection cable for pressure, temperature and external sensors to mobile devices, ODU/open ends, 10 m	0553 0502
Extension cable for mobile instruments, ODU / ODU, 10 m	0553 0504
ODU plug for connection to mobile devices	Z604 0104



Clamp-on ammeter

CLAMP ON AMMETER	ORDER-NO.
Clamp-on ammeter 0 ... 1000 A TRMS incl. 3 m connection ends	0554 0519
Clamp-on ammeter 0 ... 400 A TRMS incl. 3 m connection ends	0554 0511



Suitable sensors for DS 500 mobil, DS 400 mobil, PI 500



CURRENT/EFFECTIVE POWER METER	ORDER-NO.
CS PM 600 mobile current/effective power meter up to 100 A	0554 5341
CS PM 600 mobile current/effective power meter up to 600 A	0554 5342
- Mobile current effective power meter with 3 external current transformers for big machines and plants <ul style="list-style-type: none"> • External current transformers for clamping around the phases (100 A or 600 A) • External magnetic measuring tip for measuring the voltage • measures kW, kWh, cos, phi, kVar, kVA • Data transfer to DS 500 mobile / DS 400 mobile via Modbus • Incl. connection cable for mobile current/effective power meter to mobile instruments, 5 m 	
Current transformer 100A/1A consisting of 3 transformers for mobile instruments	Z554 0001
Current transformer 600A/1A consisting of 3 transformers for mobile instruments	Z554 0002
Current transformer 1000A/1A consisting of 3 transformers for mobile instruments	Z554 0003

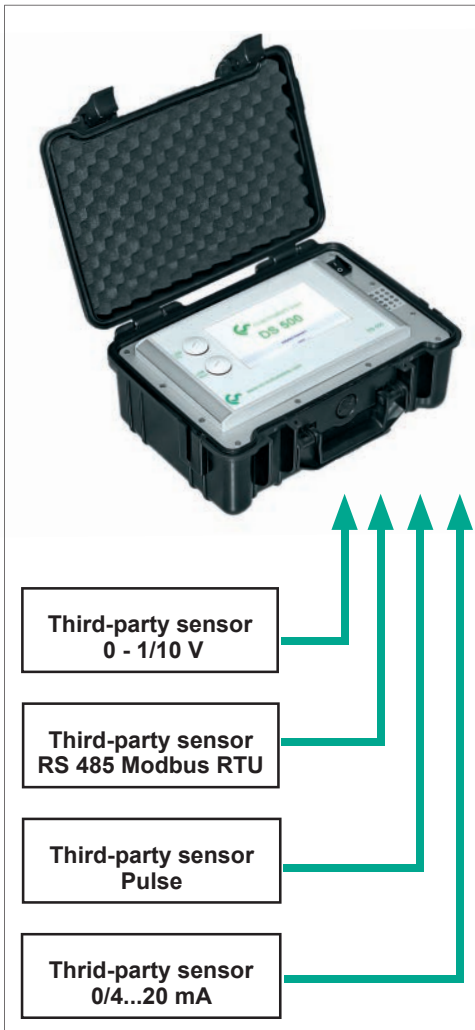

ANY THIRD-PARTY SENSOR CONNECTABLE
Additionally, any third-party sensors with the following signal outputs can be connected: <ul style="list-style-type: none"> • 4-20 mA • 0-20 mA • 0-1 V / 0-10 V / 0-30 V • Pt 100 (2- or 3-wire) • Pt 1000 (2- or 3-wire) • Pulse outputs (e. G. of gas gas meters) • Frequency output • Modbus protocol

CS PM 600 -

Mobile current/effective power meter suitable for:

DS 500 mobile / DS 400 mobile / PI 500

Measures voltage, current and calculates:

- Active power [kW]
- Apparent power [kVA]
- Reactive power [kVar]
- Active energy [kWh]
- cos phi



Current transformer can be opened

Magnetic voltage measuring tips electrically isolated

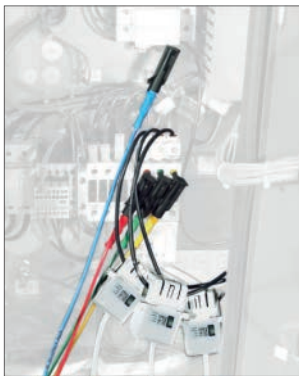

Special features:

- Magnetic voltage measuring tips for measuring the voltage during operation
- Hinged current transformers encompass the conductors of the phases L1, L2, L3. This can also be done during operation

All measured data are transferred digitally (Modbus) to DS 500 mobile/ DS 400 mobile and can be recorded there.



Example: Measurement at a compressor

TECHNICAL DATA CS PM 600

Parameters:	Voltage (Volt) Current (Ampere) Cos phi Active power (kW) Apparent power (kVA) Reactive power (kVar) Active energy (kWh) Supply frequency (Hz) All parameters are transferred digital to DS 500 mobile/DS 400 mobile
Accuracy current measurement:	Threshold values for current deviation. Loss angle according to IEC 60044-1. Current deviation in % at rated current in 120 % 1 100 % 1 20 % 1,5 5 % 3
Accuracy active energy:	IEC 62053-21 Class 1
Sensor connections:	3 x current transformers (L1,L2,L3,N) 4 x voltage measurement (L1,L2,L3,N)
Interface:	RS 485 (Modbus protocol)
Measure range:	Voltage measurement max. 400 Volt Current measurement max. 100 A resp. 600 A
Size current transformers:	100 A / 1 A (max.24 mm wire) 600 A / 1 A (max. 36 mm wire)
Dimensions case:	270 x 225 x 156 mm (B x H x T)
Operating temperature:	- 10...+40°C

DESCRIPTION	ORDER-NO.
CS PM 600 current/effective power meter up to 100 A	0554 5341
CS PM 600 current/effective power meter up to 600 A	0554 5342
<ul style="list-style-type: none"> • Mobile current effective power meter with 3 external current transformers for big machines and plants • External current transformers for clamping around the phases (100 A or 600 A) • External magnetic measuring tip for measuring the voltage • Misst kW, kWh, cos, phi, kVar, kVA • Data transfer via Modbus • Incl. connection cable for mobile current/effective power meter to mobile instruments, 5 m 	
Current transformer 100A/1A consisting of 3 transformers for mobile instruments	Z554 0001
Current transformer 600A/1A consisting of 3 transformers for mobile instruments	Z554 0002
Current transformer 1000A/1A consisting of 3 transformers for mobile instruments	Z554 0003



Energy analysis - flow measurement - leakage calculation

DS 500 mobile - Energy analysis according to DIN EN 50001

If we talk about operational costs of compressed air plants we are actually talking about the energy costs as they make up about 70 to 80 % of the total costs of a compressed air plant.

Depending on the size of the plant this means considerable operating costs. Even in smaller plants this may quickly add up to 10 000 to 20 000 € per year.

This amount can be considerably reduced - even in case of well operated and maintained plants. For sure this also applies to your compressed air plant!

Which are your actual costs per generated m³ air? Which energy is gained due to the waste heat recovery? What is the total performance balance of your plant?



What is the differential pressure of individual filters? What is the humidity (pressure dew point)? How much compressed air is consumed?

Although compressed air is one of the most expensive forms of energy, there are often enormous energy losses in factories, especially in this area.

They are mainly caused by the following factors:

- Disuse of the waste heat
- Leakages of up to 50%
- Missing compressor control systems
- Pressure losses

Lots of plants are not adapted to the actual demand or they are in need of repair. Leak curing programs could save up to about 1.7 million tons of emissions of carbon dioxide per year. (Source: Fraunhofer Institut, Karlsruhe). So there is a considerable amount of possible energy savings slumbering in the compressed air lines of lots of enterprises.

To tap into this, the heat generated during compressed air generation should be used to heat the space or to heat water. Furthermore, it is important to optimize the control of compressed air stations because this will lead to considerable energy savings in any case.

Also the restoration of an ailing or no longer suitable compressed air supply will pay off already after a short period of time. Losses due to leakages within the pipe work can cause extreme costs.

This table shows the annual energy costs incurred by leaks:

Hole diameter mm	Air loss at		Energy loss at		Costs at	
	6 bar (1/s)	12 bar (1/s)	6 bar (kWh)	12 bar (kWh)	6 bar (€)	12 bar (€)
1	1,2	1,8	0,3	1,0	144,00	480,00
3	11,1	20,8	3,1	12,7	1.488,00	6.096,00
5	30,9	58,5	8,3	33,7	3.984,00	16.176,00
10	123,8	235,2	33,0	132,0	15.840,00	63.360,00

(Source: Druckluft-Effizient, kW x 0.06 € x 8000 working hours per year)

Energy resources like electricity, water and gas are usually monitored and therefore the costs are transparent.

Water consumption, for example, is measured with consumption meters and a water leak is usually found quickly due to the visibility of the leak. Compressed air leaks on the other hand are often not noticed and can „silently“ cause a lot of unnecessary costs, even during production downtime or during the weekend.

The compressors continue to run during this time just to maintain a constant pressure in the network. For mature compressed air networks, the leak rate can be between 25 and 35 percent. They are the most industrious consumers working 365 days a year.

Not considered in these considerations are the costs of „producing clean and dry“ compressed air. Refrigeration and adsorption dryers dry the air with significant operating costs, which then meaningless „fizzles“.

With ever-increasing energy costs, these potential savings must be used more and more to stay competitive within the market. Only if the consumption of individual machines or plants is known and made transparent for all, savings potential can be used

When introducing an energy management system according to DIN EN 16001, all consumers have to be recorded in the first step.

This gives the user an overview of what is being consumed. This transparency makes it possible to deliberately intervene and save energy. In compressed air systems this means, in the first step, to detect and eliminate leaks.

Especially for the complete monitoring and consumption analysis of compressor stations and compressed air lines we developed a portable measuring system, the DS 500 mobile.

DS 500 mobile meets with all requirements for analyzing a compressed air system.

In addition to the evaluation of standard sensors like for example flow, pressure dew point, pressure, differential pressure, absolute pressure and temperature sensors, also the connection of all kinds of third-party sensors like e. g. PT100, PT1000, 0/4..20 mA, 0-1/10 V, pulse, RS 485 Modbus etc. is possible.

One of the main advantages of DS 500 mobile is the possibility to connect not only clamp-on ammeters but also external current meters, water meters or heat meters. So the current costs can be included very accurately in the analysis.



Determination of typical key figures of a compressed air station.

DS 500 mobile enables an intelligent energy analysis in a quick and easy way. The data will be indicated immediately in the display.

For this purpose just the costs in € per kWh (please consider day and night tariff) have to be entered.

By means of a mathematical function typical calculations can be carried out like for example:

- **Costs in € per generated m³ of compressed air**
- **Specific output in kWh/m³**
- **Consumption of single compressed air lines including summation**
- **Indication of Min-Max values, average value**

If the minimum values rise continuously over the years this is a clear signal that the leakage rate increases. This can easily be determined by carrying out the measurements in regular intervals.

Consumption analysis including statistics at the touch of a button

Besides the compressed air also all other energy costs like current, water, vapor etc. can be recorded in this evaluation. This creates transparency.

So all energy and flow meters for compressed air, gas, water, vapor and so on can be recorded and evaluated. The customer gets the costs in Euro. On the big 7" color display with touch panel all information are visible at a glance. By means of the evaluation software CS Soft Basic all data can be evaluated online at the PC via a USB stick or Ethernet. Additionally to the consumption analysis as daily/weekly or monthly report an alarm can be sent by e-mail or SMS in case of an exceeding of the threshold values. The measured data can be retrieved all over the world via the webserver, GSM module.

How is this done in practice?

Step 1: Measurement

It is a special advantage that up to 12 compressors can be measured with one DS 500 mobile at the same time.

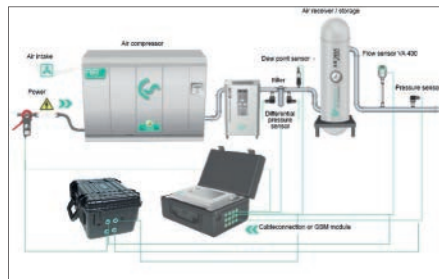

Step 2: Analysis

2.1) Compressor analysis (current-/power measurement)

The energy consumption of every single compressor is measured by means of a clamp-on ammeter. The produced compressed air quantity is calculated by the software on a basis of the performance data of the compressor which have to be entered.

The following parameters are calculated additionally: Energy consumption in (kWh), load-, unload-, stop time, compressor load in %, number of load/unload cycles, specific energy in kWh/m³, costs for 1 m³ in €.

2.2) System analysis (current measurement and real flow measurement)

The system analysis has the same function like the compressor analysis, however, it additionally offers the possibility to measure the actually produced resp. used quantity of compressed air by means of the flow sensor VA 500.

With the additional „real flow measurement“ the leakages and therefore the cost share of the leakages in comparison to the total costs in € can be determined.

2.3) Leakage calculation

The leakage calculation is done during the production free time (shutdown, weekend, holidays). The flow sensor VA 500 measures the supplied quantity of air. During the down time the compressor delivers compressed air in order to keep a constant pressure.

According to statistics even if production is carried out day and night there is at least one short period of time during which all load is switched off. By means of this data the software defines a leakage rate and calculates the incurred leakage costs in €.

Step 3: Evaluation at the PC with graphics and statistics

3.1) Entry of necessary parameters

Specific data have to be entered before the analysis is carried out:

- **Selection of compressor type (load/idle resp. variable speed drive controlled)**
- **As well as entry of the performance data according to data sheet**
- **Period of measurement**
- **Costs in € for 1 kWh**

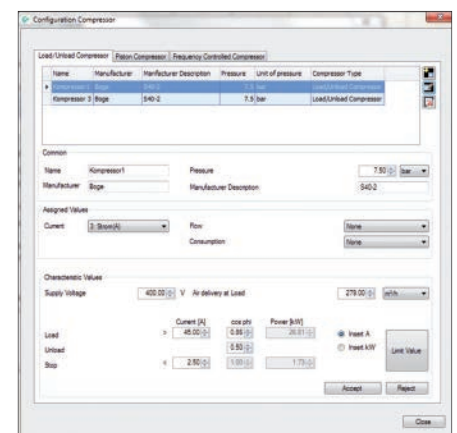

3.2) Graphic evaluation with day view and week view

Everything at a glance: The user gets a day and week view of all stored measured data with his company logo (can be easily integrated) at the touch of a button. By means of the zoom and the cross lines function peak values can be determined.

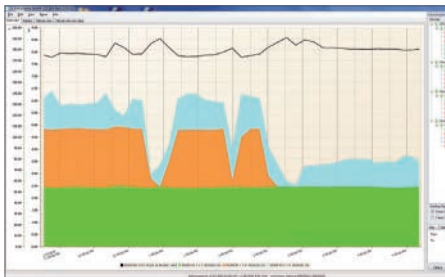

3.3) Compressed air costs in €

At the touch of a button the user gets all important data like e. g.:

- Energy costs
- Compressed air costs
- Leakage costs in €
- Compressor data with load/ unload time
- Specific energy in kWh/m³
- Costs per m³ in €

Analysis of Compressor-Energy and -Costs														
Timeperiod:		1/12/2010 10:28 AM - 1/13/2010 9:44 AM					Tariff1:		6:00 AM - 7:30 PM					
Timeperiod in hours:		167.1					Tariff2:		0:15 Euro					
Total flow rate:		Sum of selected compressors					Tariff3:		6:00 PM - 6:00 AM					
Leakoff of leakage:		129.00					Tariff4:		0:11 Euro					
Compressor	Model	Capacity (m³/min)	Pressure (bar)	Power (kW)	Efficiency (%)	Flow (m³/min)	Energy (kWh)	Cost (€)	Leakage (m³/min)	Leakage Cost (€)	Specific Energy (kWh/m³)	Cost per m³ (€)	Availability (%)	Notes
C1	1000	10	7	15	85	100	1500	22.50	0	0	0.225	0.225	100	
C2	1000	10	7	15	85	100	1500	22.50	0	0	0.225	0.225	100	
C3	1000	10	7	15	85	100	1500	22.50	0	0	0.225	0.225	100	
C4	1000	10	7	15	85	100	1500	22.50	0	0	0.225	0.225	100	
C5	1000	10	7	15	85	100	1500	22.50	0	0	0.225	0.225	100	
Summary						500	7500	112.50	129.00	11.25	0.225	0.225	100	

4) Measures

Based on these analysis some measures should be carried out in order to optimize the compressed air system. These measures may differ from system to system, however, normally there are the following possibilities:

- Please check whether there are leakages in the compressed air system and localize them. Usually they occur at weld seams and junctions. (50 holes with a diameter smaller than 1 mm may cause costs of 11 000 Euro per year).
- By means of the load/unload analysis and the pressure profile the compressor regulation and adjustment should be optimized. Modern compressor operation systems help to minimize the unload times. (During unload times the compressor takes up about 30 % of the full load energy, however, it does not release any air)
- Please reduce - if possible - the pressure (a pressure reduction of about 100 kPa saves 8 % of the energy).
- Reduce the input temperature (a temperature reduction by about 10 °C can save 3 % of the energy).
- Optimize the pipe system by avoiding unnecessary pressure drops.



DP 500/510 - Mobile dew point meters with data logger

Applications:

- Compressed air: Examination of refrigeration, membrane, adsorption dryers
- Technical gases: Residual moisture measurement in gases such as N₂, O₂ etc.
- Plastic industry: Examination of granulate dryers

Special features:

- Precise dew point measurement down to -80°Ctd
- Quick response time
- 3.5" graphic display / easy operation via touch screen
- Integrated data logger for storage of the measured values
- USB interface for reading out via USB stick
- Calculates all necessary moisture parameters like g/m³, mg/m³, ppm V/V, g/kg, °Ctdatm
- 2nd freely assignable sensor input for third-party sensors (only DP 510)
- International: Up to 8 languages selectable



Transfer of data per USB stick to the PC

2nd freely assignable sensor input for third-party sensors (only DP 510)



Quick installation by means of measuring chamber and quick connector



Ideal for service technicians - everything in one case



Dry container - for sensor protection and quick adaptation time

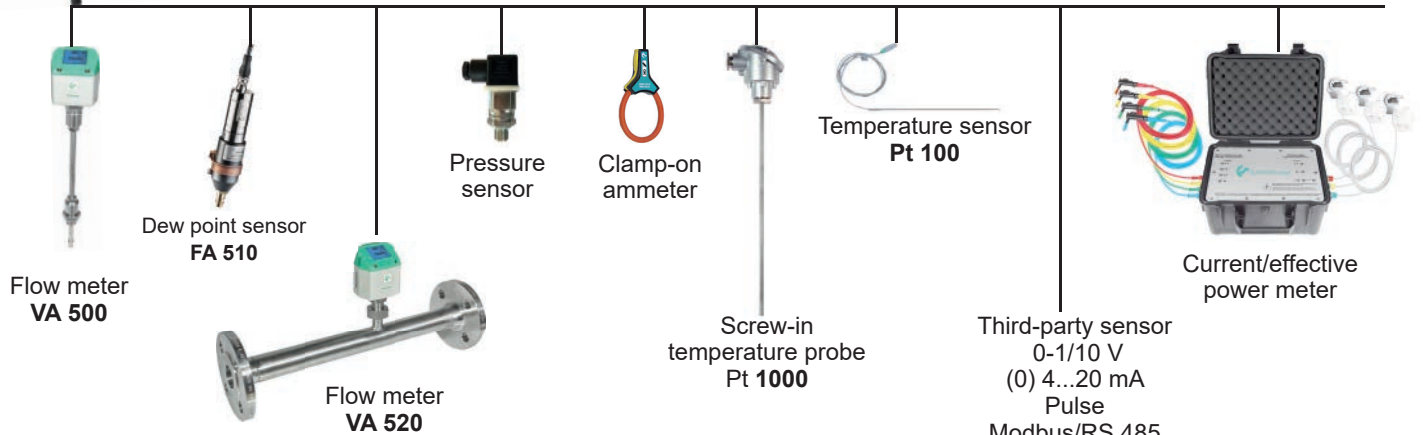

The whole range of suitable sensors can be found on pages 30 to 33

Everything a glance

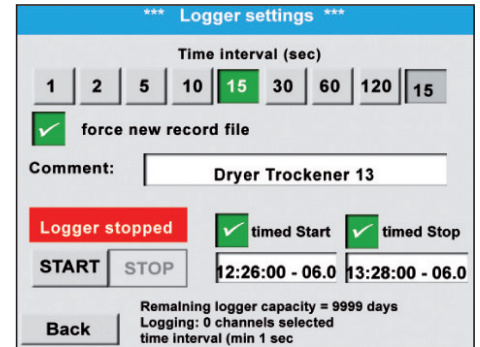
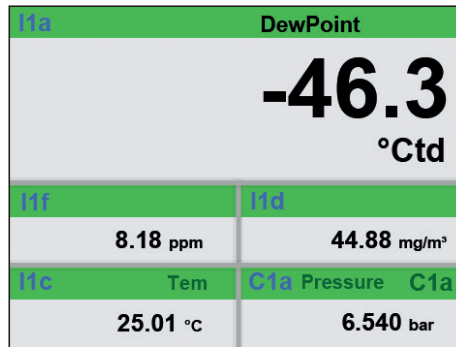
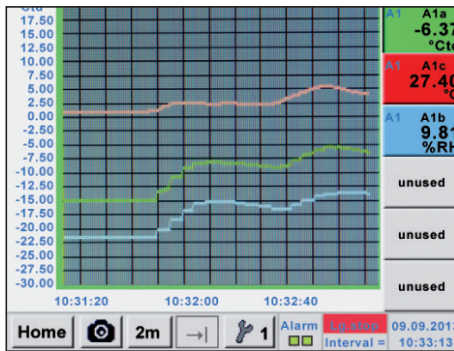

Gradients are displayed graphically, so the operator sees at a glance the behavior of the dryer since the start of the measurement.

All physical parameters of the humidity measurement are calculated automatically. The DP 510 also displays the measured values of the external sensor.

Up to 100 million readings can be stored. Each measurement may be accompanied by a comment, e. g. location name. The time interval can be determined freely.

DESCRIPTION	ORDER-NO.
Set DP 500 in a case - consisting of:	0600 0500
- Portable dew point meter DP 500 for compressed air and gases	0560 0500
- Mobile measuring chamber up to 16 bar	0699 4490
- Diffusion-tight PTFE hose with quick connector, length 1 m	0554 0003
- Power supply for DP 500/510	0554 0009
- Control and calibration set 11.3 % RH	0554 0002
- Quick-lock coupling	0530 1101
- Dry container for CS dew point sensors	0699 2500
- Transportation case (small) for DP 500	0554 6500
Set DP 510 in a case - consisting of:	0600 0510
- Mobile dew point meter DP 510 with one additional input external sensors	0560 0510
- Mobile measuring chamber up to 16 bar	0699 4490
- Diffusion-tight PTFE hose with quick connector, length 1 m	0554 0003
- Power supply for DP 500/510	0554 0009
- Control and calibration set 11.3 % RH	0554 0002
- Quick-lock coupling	0530 1101
- Dry container for CS dew point sensors	0699 2500
- Transportation case (large) for DP 510 as well as other sensors	0554 6510
Further options, not included in the set:	
Option: „Mathematics calculation function“ for 4 freely selectable channels, (virtual channels): addition, subtraction, division, multiplication	Z500 5107
Option: „Totalizer function for analogue signals“	Z500 5106
CS Basic – data evaluation graphically and in tabular form - reading of the measured data via USB or Ethernet, license for 2 workstations	0554 8040
Precision calibration at -40°Ctd or 3°Ctd with ISO certificate	0699 3396
Additional calibration point freely selectable in the range between -80...+20°Ctd	0700 7710
High pressure measuring chamber up to 350 bar	0699 3590
Measuring chamber for atmospheric dew point	0699 3690
Measuring chamber for granulate driers with minimum overpressure	0699 3490
Portable dew point meter DP 510 for compressed air and gases (high pressure version up to 350 bar)	0560 0512
Portable dew point meter DP 500 for compressed air and gases (high pressure version up to 350 bar)	0560 0501



Photo key saves current screen as an image file. No additional software necessary.

TECHNICAL DATA DP 500/510	
Display:	3.5" Touch screen
Measuring range:	-80...+50°Ctd -20...+70°C 0...100 %rF
Accuracy:	± 0,5°Ctd bei -10...+50°Ctd Typ. ± 2°Ctd (remain. range)
Moisture parameters:	g/m³, mg/m³, ppm V/V, g/kg, °Ctdatm, %rF
Pressure range:	-1...50 bar standard -1...350 bar special version
Interface:	USB interface
Data logger:	8 GB SD memory card (100 millions values)
Power supply for sensors:	Output voltage: 24 VDC ± 10% Output current: 120 mA continuous operation
Power supply:	Internal rechargeable Li-Ion batteries, approx 12 h continuous operation, 4 h charging time
Screw-in thread:	G 1/2" stainless steel
Ambient temperature:	0...+50°C
EMV:	DIN EN 61326-1



DP 400 mobile - with integrated dew point and pressure measurement

For measurement of all humidity parameters under pressure up to 16 bar.

The portable dew point meter with integrated, rechargeable battery has been developed especially for the field use. Besides a highly precise dew point sensor the device also contains a precise pressure sensor up to 16 bar. So in addition to the dew point in °Ctd, the temperature in °C and the line pressure in bar also further moisture parameters (% RH, mg/m³, g/m³) as well as pressure-dependent measuring values (g/kg, ppm v/v, atm. dew point °C) can be calculated.



SPECIAL FEATURES:

- Precise dew point measurement down to -80°Ctd
- Robust case for field use
- Integrated pressure measurement up to 16 bar
- Integrated measuring chamber with integrated dry container protects the dew point sensor during transport and grants a quick adaptation time
- Long-time stable humidity sensor: precise, insensitive against dewing, quick adaptation time
- Optionally available: 2 further sensor inputs for external sensors
- Optionally available: Integrated data logger



6 mm plug connection for measuring gas/compressed air feed

Option:
2 further sensor inputs (for flow, pressure, dew point, 4...20 mA, Modbus RTU...)

Easy operation via touchscreen

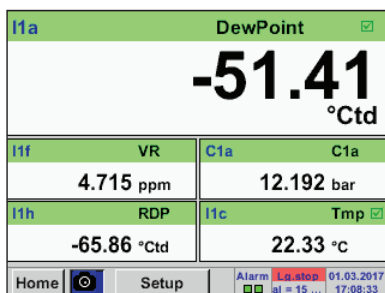

Actual measured values

All measured values are visible at a glance. Exceed of limit value is indicated in red. Due to the integrated pressure sensor DP 400 mobile is able to calculate the atmospheric dew point.

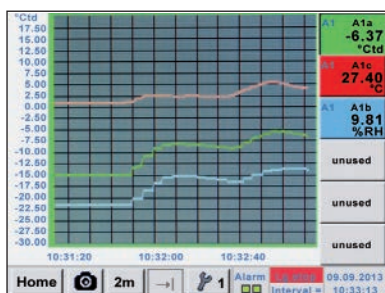

Graphic view

In the graphic view all measured values are indicated as curves. It is possible to browse back on the time axis by a slide of the finger (without data logger maximum 24 h, with data logger back to the start of the measurement).



Data logger

Measured values are stored in DP 400 by means of the option „integrated data logger“. The time interval can be freely set. Furthermore there is the possibility to fix the starting time and the end time of the data recording. Read-out of the measured data via USB interface or via the optional Ethernet interface.

DESCRIPTION	ORDER-NO.	TECHNICAL DATA DP 400 MOBIL
DP 400 mobile - Portable dew point meter with integrated pressure measurement, incl. transportation bag for teflon hose and power supply	0500 4505	Display: 3.5" Touch screen
Option: Integrated data logger for 100 million measured values	Z500 4002	Measuring range: -80...+50°Ctd -20...+70°C 0...100 % rF 0...16 bar ± 0,5 %
Option: Integrated Ethernet and RS 485 interface	Z500 4004	Accuracy: ± 1°C bei 50...-20°Ctd ± 2°C bei -20...-50°Ctd ± 3°C bei -50...-80°Ctd
Option: Integrated webserver	Z500 4005	Humidity parameters: g/m ³ , mg/m ³ , ppm V/V, g/kg, °Ctdatm, % rF
Option: „Mathematics calculation function“ for 4 freely selectable channels, (virtual channels): addition, subtraction, division, multiplication	Z500 4007	Interface: USB interface
Option: 2 additional sensor inputs for external sensors (1 x digital sensor Modbus, 1 x analog sensor)	Z500 4001	Option Data logger: 8 GB SD memory card (100 millions values)
CS Basic – data evaluation graphically and in tabular form - reading of the measured data via USB or Ethernet, license for 2 workstations	0554 8040	Voltage supply for external sensors: Output voltage: 24 VDC ± 10% Output current: 120 mA in long-term use
Connection cable for VA/FA series on mobile instruments, ODU/M12, 5m	0553 1503	Current supply: Internally loadable Li-Ion batteries approx. 12 h continuous operation, 4 h charging time
Connection cable for pressure, temperature or external sensors on mobile instruments, 5 m	0553 0501	Connection: 6 mm plug connections
Connection cable for pressure, temperature or external sensors on mobile instruments, 10 m	0553 0502	Ambient temperature: 0...+50°C
Extension cable for mobile instruments ODU/ODU, 10m	0553 0504	EMV: DIN EN 61326-1



FA 510/515 - Dew point sensor

FA 510/515 for residual moisture measurement in compressed air and gases



Typical applications:

- Dew point measurement in the compressed air after adsorption dryer, membrane dryer, refrigeration dryer
- Residual moisture/ dew point measurement in gases like oxygen, nitrogen, argon ...
- Residual moisture/ dew point measurement after granulate dryers in plastics industry

Recommendation:

Mounting with standard measuring chamber for compressed air up to 16 bar

Advantage: Easy installation via quick coupling

Special features:

- Extremely long-term stable
- Analog output 4 ... 20 mA for dew point
- Condensation insensitive
- Fast adjustment time
- Pressure resistant up to 350 bar (special version)
- **NEW:** Modbus RTU interface
- **NEW:** Higher resolution of the sensor signal due to improved evaluation electronics
- **NEW:** Sensor diagnosis on site with mobile device or CS service software
- Readable via Modbus:
 - Pressure dew point [° Ctd.]
 - Temperature [° C]
 - Rel. humidity [% RH]
 - Abs. humidity [g / m³]
 - Moisture content [g / m³]
 - Moisture content V / V [ppmV / V]
 - Partial vapor pressure [hPa]
 - Atmospheric dew point [° Ctd.atm]

DESCRIPTION	ORDER-NO.
FA 510 dew point sensor for desiccant driers -80°...20°Ctd incl. inspection certificate, 4...20 mA output signal (3-wire connection) and Modbus-RTU interface	0699 0510
FA 515 dew point sensor for desiccant driers -80°...20°Ctd incl. inspection certificate, 4...20 mA output signal (2-wire connection) or Modbus-RTU interface	0699 0515
FA 510 dew point sensor for desiccant driers -20...50°Ctd incl. inspection certificate, 4...20 mA output signal (3-wire connection) and Modbus-RTU interface	0699 0512
FA 510 dew point sensor for desiccant driers -20...50°Ctd incl. inspection certificate, 4...20 mA output signal (2-wire connection) and Modbus-RTU interface	0699 0517
Connection cables:	
Connection cable for VA/FA sensors, 5 m	0553 0104
Connection cable for VA/FA sensors, 10 m	0553 0105
Option for FA 510:	
Option: analogue output FA510, Special version 2...10 Volt	Z699 0510
Options for FA 510/515:	
Option: max. pressure FA5xx 350 bar	Z699 0515
Option: special scaling FA5xx 4...20 mA=___ ... ___ g/m³, ppm etc.	Z699 0514
Option: connection thread FA5xx, 5/8" UNF	Z699 0511
Option: connection thread FA5xx, 1/2" NPT	Z699 0512
Option: surface condition FA5xx, free of oil & grease	Z699 0517
Additional accessories:	
Standard measuring chamber up to 16 bar	0699 3390
High pressure measuring chamber up to 350 bar	0699 3590
Measuring chamber, stainless steel 1.4305	0699 3290
CS Service Software for dew point sensors incl. PC connection set (Modbus to USB Interface)	0554 2007
Calibration and adjustment:	
Precision calibration at -40°Ctd or 3° Ctd including ISO certificate	0699 3396
Additional calibration point freely selectable	0700 7710

TECHNICAL DATA FA 510/515	
Measure range:	-80...20°Ctd, -20...50°Ctd
Accuracy:	± 1°C to 50...-20°Ctd ± 2°C to -20...-50°Ctd ± 3°C to -50...-80°Ctd
Pressure range:	-1...50 bar special version up to 350 bar
Power supply:	24 VDC (16...30 VDC)
Protection class:	IP 65
EMV:	according to DIN EN 61326-1
Operating temp.:	-20...70 °C
Connection:	M12, 5-pole
PC connection	Modbus-RTU interface (RS 485)
Analog output	4...20 mA = -80...20°Ctd 4...20 mA = -20...50°Ctd FA 510: 4...20 mA (3-wire) FA 515: 4...20 mA (2-wire)
Burden for analog output:	< 500 Ω
Screw-in thread:	G 1/2" optional: UNF 5/8", NPT 1/2"
Dimensions:	Ø 30 mm, length approx. 130 mm
Via service software:	
Choose units	% RH, °Ctd, g/m³, mg/m³, ppm V/V
Scaling	change 4...20 mA

DS 52 - Dew point monitoring

The dew-point set is wired ready to plug in at the factory. The alarm values can be set freely. The dew point sensor FA 510 is extremely long-term stable and can be quickly and easily installed and removed under pressure via the screw-on measuring chamber incl. Quick coupling.

Option:
Alarm unit
(Buzzer and continuous red light)

Consisting of:
Digital process meter DS 52

Special features:

- System ready for plug-in: Everything completely wired
- No time-consuming studying of the instruction manual
- 2 alarm contacts (230 VAC, 3 A) pre- and main alarm freely adjustable
- 4...20 mA analogue output
- Option alarm unit: Buzzer and continuous red light



DESCRIPTION	ORDER-NO.
Dew point monitoring DS 52 for desiccant driers consisting of:	0600 5100
DS 52 LED display in wall housing	0500 0009
FA 510 dew point sensor for desiccant driers -80°...20°Ctd incl. inspection certificate, 4...20 mA output signal (3-wire connection) and Modbus-RTU interface	0699 0510
Standard measuring chamber up to 16 bar	0699 3390
Connection cable for VA/FA sensors, 5 m	0553 0104
Dew point monitoring DS 52 for refrigeration dryers, consisting of:	0600 5120
DS 52 LED display in wall housing	0500 0009
FA 510 dew point sensor for refrigeration dryer -20...50°Ctd incl. inspection certificate, 4...20 mA output signal (3-wire connection) and Modbus-RTU interface	0699 0512
Standard measuring chamber up to 16 bar	0699 3390
Connection cable for VA/FA sensors, 5 m	0553 0104
Options:	
Power supply 24 VDC (instead of 230 VAC)	Z500 0001
Power supply 110 VAC (instead of 230 VAC)	Z500 0002
Alarm unit mounted at wall housing	Z500 0003
Alarm unit for external mounting with 5 m cable	Z500 0004
Calibration and adjustment:	
Precision calibration at -40°Ctd including ISO certificate	0699 3396
Additional calibration point freely selectable	0700 7710

TECHNICAL DATA DISPLAY DS 52	
Dimension:	118 x 92 x 93 mm
Display:	LED red, 7 segments, height: 13 mm, 5 digits, 2 LED for alarm relay
Keypad:	4 keys
Input:	4...20 mA
Power supply:	230 VAC, 50/60 Hz; Option: 24 VDC or 110 VAC 50/60 Hz
Alarm outputs:	2 x relay output, changeover contact, 250 VAC, max. 3 A
Operating temperature:	-10...+60 °C (storage temperature -20°C...+80°C)
Alarm thresholds:	freely adjustable
Hysteresis:	2 °Ctd
Analog output:	4...20 mA = -80...20 Ctd or -20...50°Ctd.



FA 515 Ex Dew point sensor - for residual moisture measurement in potentially explosive areas

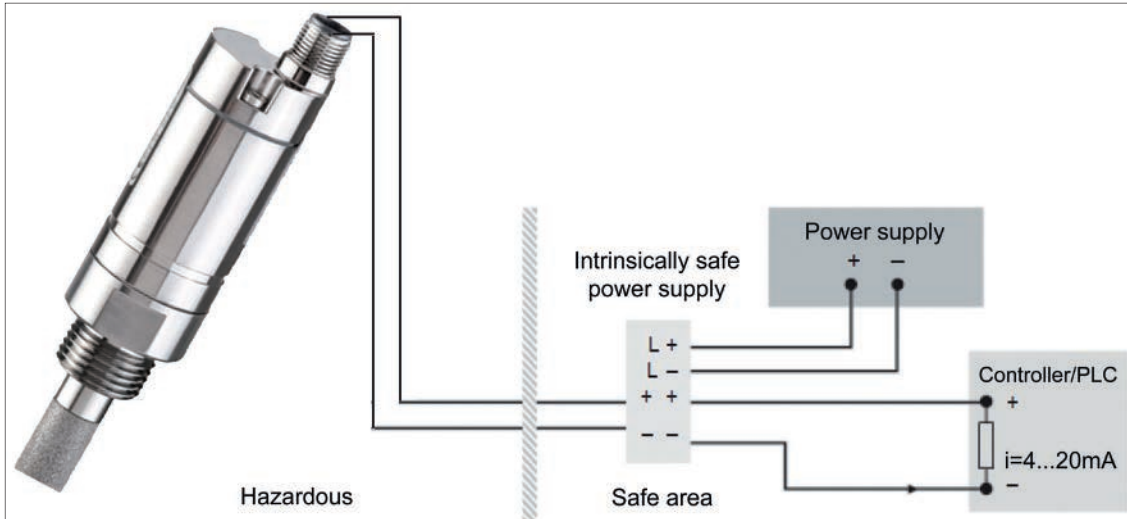

The FA 515 Ex measures dew point resp. pressure dew point in potentially explosive atmospheres and can be used in many non-aggressive gases.

Typical applications:

- Air / Compressed air
- Argon
- Nitrogen
- Biogas
- Natural gas
- Hydrogen
- etc...

Special features:

- Robust design
- Pressure-tight up to 500 bar
- Long-term stable humidity sensor, approved for years
- 4...20 mA analogue output in 2-wire technology
- Further parameters adjustable via software: % RH, g/m³, mg/m³, ppm V/V, g/kg
- **NEW:** Higher resolution of the sensor signal due to improved evaluation electronics

Approvals:

- II 2 G Ex ib IIC T4 Gb Zone 1, gas, intrinsically, temp. 135 °C
- II 2 D Ex ib IIIC T80°C Db Zone 21, dust, intrinsically, temp. 80 °C

FA 515 Ex may only be used in connection with approved Ex-rated power supplies or safety barriers or galvanic separating elements with max.:

U₂ = 28 V max.
I₂ = 93 mA max.
P₂ = 0,65 W max.

TECHNICAL DATA FA 515 EX	
Measuring range:	-80...+20 °Ctd = 4...20 mA
Pressure range:	-1...500 bar
Power supply::	24 VDC (10...30 VDC)
Accuracy:	± 1 °C to -20...+20 °Ctd ± 2 °C to -50...-20 °Ctd ± 3 °C to -80...-50 °Ctd
Output:	4...20 mA in 2-wire technology
Protection class:	IP 65
EMV:	according to DIN EN 61326-1
Operating temp.:	-20...+70 °C
Storage temp.:	-40...+80 °C
Burden for analogue output:	< 500 Ω to 24 V
Screw-in thread:	G 1/2" stainless steel, optional 5/8" UNF
Connection:	M12 4-pin
Sensor protection:	Sintered filter 50 µm stainless steel

DESCRIPTION	ORDER-NO.
FA 515 Ex pressure dew point meter	0699 5515
Measuring chamber up to 350 bar	0699 3590
Measuring chamber made of stainless steel	0699 3290
Special scaling, analogue output to other humidity parameters: %RH, g/m ³ , mg/m ³ , ppm V/V, g/kg	Z699 0514
Intrinsically safe power supply, safety barriers	0554 3071



FA 550 dew point sensor - in robust die-cast aluminum housing

The FA 550 is ideal for outdoor dew point measurements or rougher industrial environment



Special features:

- Robust, waterproof die-cast aluminum housing, IP 67
- Alarm relay - limit value adjustable via buttons (max 60VDC, 0.5 A)
- 4 ... 20 mA analog output
- Optional: 2 pieces 4 ... 20 mA analog output e.g. for dew point and temperature
- Extremely long-term stable
- Fast adjustment time
- Pressure resistant up to 500 bar (optional)
- **NEW:** Modbus RTU interface
- **NEW:** Ethernet interface (optional)
- **NEW:** Higher resolution of the sensor signal due to improved evaluation electronics
- **NEW:** Sensor diagnosis on-site with handheld device or CS Service Software
- Readable via Modbus: pressure dew point [° Ctd.], temperature [° C], rel. humidity [% RH], abs. humidity [g / m³], degree of humidity [g / m³], moisture content V / V [ppmV / V], Partial vapor pressure [hPa], atmospheric dew point [° Ctd.atm]

APPLICATION:

- Dew point measurement in the compressed air after adsorption dryers/ membran dryers/refrigeration dryer
- Residual moisture measurement / dew point measurement in gases such as: oxygen, nitrogen, argon, hydrogen, natural gas, biogas ...

Easy operation via the keys on the display

The screenshots show the following display pages:

- Page 1/3:** Large display of dew point: **-47.8 °Ctd**. Status: HW: 1.02 SW:1.00 MBID:1
- Page 2/3:** Temperature: 22.10 °C, Relative Humidity: 0.1940 %rH, Absolute Humidity: 0.0378 g/m³. Status: HW: 1.02 SW:1.00 MBID:1
- Page 3/3:** Degree of Humidity: 0.0321 g/kg, Partial Vapor Pressure: 50.88 ppm, Atmospheric Dew Point: 0.0522 hPa, Atmospheric Dew Point: -47.80 °Ctd. Status: HW: 1.02 SW:1.00 MBID:1
- FA500 Alarm:** Alarm is active (checked). Unit: °Ctd, Value: -60.00, Hysteresis: 2.00. Buttons: back.
- FA500 4 - 20mA Channel 1:** State: on, Unit: °Ctd, Scale 4mA: -80.00°Ctd, Scale 20mA: 20.00°Ctd. Buttons: back.
- FA500 4 - 20mA Channel 1:** State: on, Unit: g/m³, Scale 4mA: 0g/m³, Scale 20mA: 10g/m³. Buttons: Save, Cancel.
- FA500 Pressure Setting:** Ref. Pressure: 1013.00 hpa, Sys. Pressure: 7500.00 hpa. Button: back.

The integrated display shows the dew point in big figures as well as further humidity parameters on two more display pages. The arrow key can be used to scroll between the display pages.

The alarm threshold value for the integrated relay can be entered via the keys. In addition to the alarm threshold, the hysteresis can also be freely entered.

The 4...20 mA analogue output can be scaled freely resp. also allocated to one further parameter, e. g. g/m³.

After entering the system pressure of the compressed air system and the reference pressure (atmospheric pressure), the sensor can also calculate back to the atmospheric dew point from the measured pressure dew point if desired.

Example order code FA 550:

0699 0550_A1_B1_C1_D1_E1_F1_G1_H1_I1

Measuring range	
A1	-80...+20 °Ctd. (-112 to 68 °F)
A2	-20...+50 °Ctd. (-4 to 122 °F)
A3	-40...+30 °Ctd. (-40 to 86 °F)
A4	-60...+30 °Ctd. (-76 to 86 °F)
A5	-80...+20 °Ctd. (-112 to 68 °F) (scaling 4...20 mA = -100...+20 °Ctd.)
A6	-80...+20 °Ctd. (-112 to 68 °F) (scaling 4...20 mA = -110...+20 °Ctd.)

Option Display	
B1	with integrated display
B2	without display

Option Signal output / Bus connection	
C1	2 x 4 ... 20 mA analog output (galv. isolated), alarm relay, RS 485 (Modbus RTU)
C4	1 x 4 ... 20 mA analog output (not electrically isolated), alarm relay, RS 485 (Modbus RTU)
C5	Ethernet interface (Modbus / TCP), 1 x 4 ... 20 mA analog output (not galv. isolated), alarm relay, RS 485 (Modbus RTU)
C8	M-Bus
C9	Ethernet interface PoE (Power over Ethernet) Modbus / TCP, 1 x 4 ... 20 mA analog output (not electrically isolated), alarm relay, RS 485 (Modbus RTU)

Special version analog output	
D1	No special version
D2	Special version 2...10 V

Scaling analog output	
E1	Standard scaling
E2	Special scaling 4 ... 20 mA = 0 ... x g / m ³ , ppm, g / kg etc.

Sensor protection cap	
F1	Stainless steel sintered cap (~ 50 µm)
F2	perforated stainless steel cap

Connecting thread	
G1	G 1/2"
G2	UNF 5/8"

Maximum pressure	
H1	50 bar
H2	350 bar
H3	500 bar

Surface condition	
I1	Standard design
I2	Special cleaning oil and grease-free (e. g. for oxygen application etc.)
I3	Silicone-free version including special cleaning oil and grease-free

DESCRIPTION	ORDER-NO.
FA 550 Dew point sensor in robust die-cast aluminum housing	0699 0550
Additional accessories:	
Standard measuring chamber up to 16 bar	0699 3390
High pressure measuring chamber up to 350 bar	0699 3590
Bypass measuring chamber made of stainless steel (1.4305)	0699 3290
Connection cables:	
Connection cable for probes 5 m with open ends	0553 0108
Connection cable for probes 10 m with open ends	0553 0109
Ethernet connection cable length 5 m, M12 plug x coded (8 pin) to RJ 45 plug	0553 2503
Ethernet connection cable length 10 m, M12 plug x coded (8 pin) to RJ 45 plug	0553 2504
Power supply in wall housing for max. 2 sensors VA / FA series 5xx, 100-240 VAC, 23 VA, 50-60 Hz / 24 VDC, 0.35 A	0554 0110
CS service software VA 550 incl. Interface cable to PC (USB) and plug-in power supply - for configuration / parameterization of the VA 550/570	0554 2007
PNG cable gland - for FA 550, VA 550/570	0553 0552
Calibration and adjustment:	
Precision adjustment at -40 ° Ctd or 3 ° Ctd incl. ISO certificate	0699 3396
Additional calibration point freely selectable	0700 7710

TECHNICAL DATA FA 550	
Measuring range:	-80...20 °Ctd, -60...30 °Ctd, -20...50 °Ctd, bzw. 0...100% RH
Accuracy:	± 1°C to +50...-20°Ctd ± 2°C to -20...-50°Ctd ± 3°C to -50...-80°Ctd
Pressure range:	-1 ... 50 bar, Special version up to 350 bar or 500 bar
Power supply:	24 VDC (18...30 VDC)
Protection class:	IP 67
EMC:	According to DIN EN 61326-1
Operating temp.:	-20...50 °C
Outputs:	Standard: Modbus RTU, 4 ... 20 mA active (not electrically isolated), alarm relay (max 48 VDC, 0.5 A) Options: See order code
Burden:	< 500 Ω
Material:	Housing die-cast aluminum, Sensor tube stainless steel 1.4571
Screw:	G 1/2", optional 5/8" UNF



FA 500 - Dew point sensor from -80 to 20 °Ctd

FA 500 is the ideal dew point measuring instrument with integrated display and alarm relay for refrigeration, membrane and desiccant driers.



Special features:

- Integrated display
- Threshold value adjustable via keypad alarm relay (max. 60 VDC, 0.5 A)
- Pressure-tight up to 350 bar (special version)
- Extreme long-term stability
- Quick response time
- 4...20 mA analog output
- 2 versions: Refrigeration dryers and desiccant dryers
- **NEW:** Modbus-RTU interface
- **NEW:** Higher resolution of sensor signal caused by the improved evaluation electronics
- **NEW:** Sensor diagnosis on site with a portable device or CS Service Software
- Readable via Modbus:
 - Pressure dew point [° Ctd.]
 - Temperature [° C]
 - Rel. humidity [% rh]
 - Abs. humidity [g / m³]
 - Moisture content [g / m³]
 - Moisture content V / V [ppmV / V]
 - Water vapor particle pressure [hPa]
 - Atmospheric dew point [° Ctd.atm]



The integrated keys enable an easy menu-driven operation



Upper connection:

Power supply, 4...20 mA output, Modbus-RTU output

Lower connection:

Alarm relay

Easy operation via keys on the display



The integrated display shows the dew point in big figures as well as further humidity parameters on two more display pages. The arrow key can be used to scroll between the display pages.

The alarm threshold value for the integrated relay can be entered via the keys. In addition to the alarm threshold, the hysteresis can also be freely entered.

The 4...20 mA analogue output can be scaled freely resp. also allocated to one further parameter, e. g. g/m³.

After entering the system pressure of the compressed air system and the reference pressure (atmospheric pressure), the sensor can also calculate back to the atmospheric dew point from the measured pressure dew point if desired.

DESCRIPTION	ORDER-NO.
FA 500 dew point sensor for refrigeration driers, -20...50 °Ctd	0699 0501
FA 500 dew point sensor for desiccant driers, -80...20 °Ctd	0699 0502
FA 500 dew point sensor for desiccant driers, -60...30 °Ctd	0699 0503
Connection cables:	
Connection cable for VA/FA series, 5 m	0553 0104
Connection cable for VA/FA series, 10 m	0553 0105
Cable for alarm/pulse output, with M12 plug, length 5 m	0553 0106
Cable for alarm/pulse output, with M12 plug, length 10 m	0553 0107
Ethernet connection cable length 5 m, M12 plug x-coded (8 pin) to RJ 45 plug	0553 2503
Ethernet connection cable length 10 m, M12 plug x coded (8 pin) to RJ 45 plug	0553 2504
Options for FA 500:	
Option: max. pressure FA5xx 350 bar	Z699 0515
Option: max. pressure FA5xx 500 bar	Z699 0516
Option: special scaling FA5xx 4...20 mA=___ ... __g/m³, ppm etc.	Z699 0514
Option: connection thread FA5xx, 5/8" UNF	Z699 0511
Option: connection thread FA5xx, 1/2" NPT	Z699 0512
Option: surface condition FA5xx, free of oil & grease	Z699 0517
Ethernet-Interface for VA500/520 and FA 500	Z695 5006
Ethernet-Interface PoE for VA500/520 and FA500	Z695 5007
M-Bus board for VA500/520 and FA500	Z695 5004
Additional accessories:	
Standard measuring chamber up to 16 bar	0699 3390
High pressure measuring chamber up to 350 bar	0699 3590
CS Service Software for FA/VA sensors incl. PC connection set, USB connection and interface adapter to the sensor	0554 2007
Mains unit in wall housing for maximum 2 sensors of the series VA/FA 5xx, 100-240 V, 23 VA, 50-60 Hz / 24 VDC, 0.35 A	0554 0110
AC adapter plug 100-240 V AC/ 24 V for VA/FA 500/520	0554 0109
Calibration and adjustment:	
Precision calibration at -40°Ctd or +3°Ctd including ISO certificate	0699 3396

TECHNICAL DATA FA 500

Measuring range:	-80...20 °Ctd, -60...30 °Ctd, -20...50 °Ctd, resp. 0...100% RH
Accuracy:	± 1°C to +50...-20°Ctd ± 2°C to -20...-50°Ctd ± 3°C to -50...-80°Ctd
Pressure range:	-1...50 bar special version up to 500 bar
Power supply:	24 VDC (18...30 VDC)
Protection class:	IP 65
EMC:	According to DIN EN 61326-1
Operation temp.:	-20...50 °C
Connection:	2 x M12, 5-pole for analog output, Modbus-RTU and alarm output, M-Bus (optional) Ethernet (PoE) (optional)
PC connection	Modbus-RTU interface (RS 485)
Output: (3-wire)	4...20 mA = -80...20°Ctd 4...20 mA = -60...30°Ctd 4...20 mA = -20...50°Ctd
Burden for analog output:	< 500 Ω
Alarm relay:	NC, max.60 VDC, 0,5 A
Screw-in thread:	G 1/2"
Dimensions of housing:	76,5 x 85 x 75 (BxHxT)



DS 400 Dew point monitoring

For stationary dew point monitoring of refrigeration or desiccant dryers. The touch screen graphic display enables an intuitive operation and shows the progress of the measured values. 2 alarm relays are available for monitoring of threshold values. Available either with a classic analogue output 4...20 mA or optionally with digital interfaces like Ethernet and RS 485 (Modbus protocol). As a stand-alone solution the measured data stored in the optional data logger can be read-out via USB stick and evaluated by means of the software CS Soft Basic.

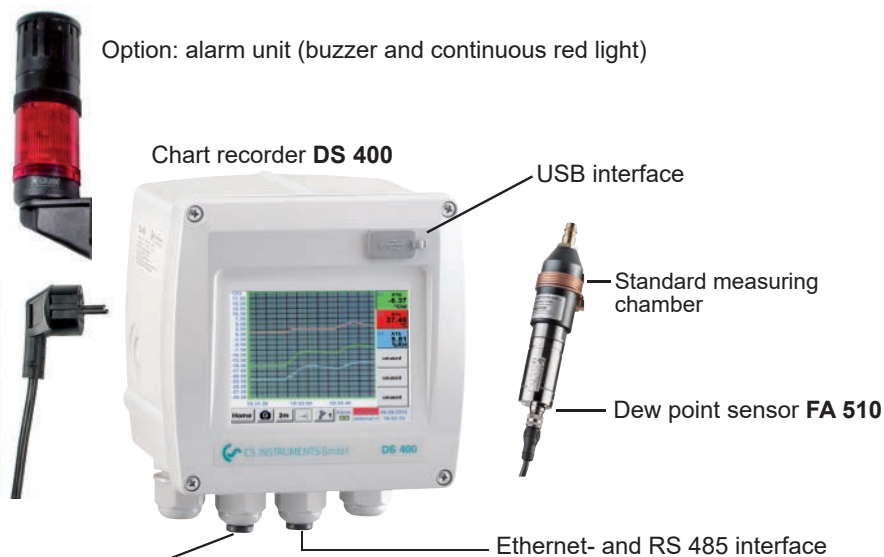

2nd sensor input for dew point -
or consumption sensors VA 500/520

Special features:

- 3.5" Graphic display – easy to use with touch-screen
- Plug-in system: everything wired and ready
- 2 alarm contacts (230 VAC, 3 A) Pre-alarm and main alarm freely adjustable
- An alarm delay can be set for each alarm relay
- 4...20 mA Analog output
- Option: Ethernet and RS 485 interface (Modbus protocols)
- Option: Webserver

Transfer the data via USB stick to the PC



- **Option:** Integrated data logger
- Record dew point curve up to 100 million readings
- CS Basic for graphical and tabular evaluation. Read out data either via USB stick or Ethernet

DESCRIPTION	ORDER-NO.
Dew point monitoring DS400 for desiccant driers (-80...+20° Ctd.)	0601 0510
Dew point monitoring DS400 for refrigeration driers (-20...+50°Ctd)	0601 0512
Options	
Option: Integrated data logger for 100 million measured values	Z500 4002
Option: Integrated Ethernet and RS 485 interface	Z500 4004
Option: Integrated webserver	Z500 4005
Option: 2 additional sensor inputs for analogue sensors (pressure sensor, temperature sensor and so on)	Z500 4001
Additional accessories	
CS Basic – data evaluation graphically and in tabular form - reading of the measured data via USB or Ethernet, license for 2 workstations	0554 8040
Alarm unit mounted at wall housing	Z500 0003
Alarm unit for external mounting with 5 m cable	Z500 0004
Calibration and adjustment	
Precision calibration at -40 °Ctd or +3 °Ctd including ISO certificate	0699 3396

TECHNICAL DATA DS 400	
Dimensions:	118 x 115 x 98 mm IP 54 (wall housing) 92 x 92 x 75 mm (panel mounting)
Inputs:	2 digital inputs for FA 510 resp. VA 500/520
Interface:	USB interface
Power supply:	100...240 VAC, 50-60 Hz
Accuracy:	please see FA 510
Alarm outputs:	2 relays, (pot. - free)
Options	
Data logger:	100 million measuring values start/stop time, measuring rate freely adjustable
2 additional sensor inputs:	for connection of pressure sensors, temperature sensors, clamp-on ammeters, third-party sensors with 4...20 mA 0 to 10 V, Pt 100, Pt 1000

TECHNICAL DATA FA 510	
Measuring range:	-80...20 °Ctd resp. -20...50 °Ctd
Accuracy:	± 1 °C at 50...-20 °Ctd ± 2 °C at -20...-50 °Ctd ± 3 °C at -50...-80 °Ctd
Pressure range:	-1...50 bar, special version up to 350 bar

Easy operation via Touch screen

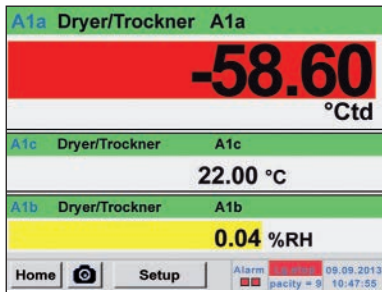

Actual measured values

All measured values can be seen at a glance. Threshold exceeding are indicated in red color. A „measuring site name“ can be allocated to each sensor.

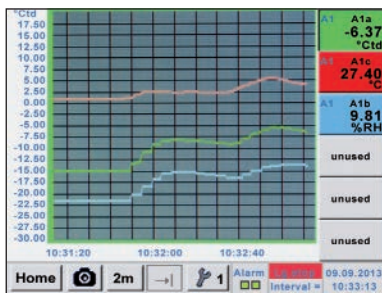

Graphic view

In the graphic view all measured values are indicated as curves. It is possible to brows back on the time axis by a slide of the finger (without data logger maximum 24 h, with data logger back to the start of the measurement).

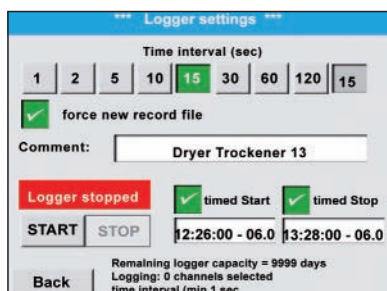

Data logger

Measured values are stored in DS 400 by means of the option „integrated data logger“. The time interval can be freely set. Furthermore there is the possibility to fix the starting time and the end time of the data recording. Read-out of the measured data via USB interface or via the optional Ethernet interface.

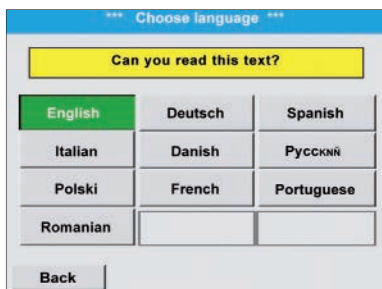

Selection of the language

DS 400 „speaks“ several languages. The required language can be selected by means of the select button.

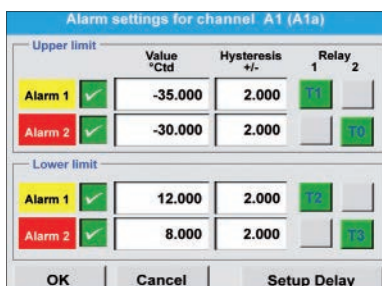

Adjustment of the alarm relays

Each one of the 2 alarm relays can be allocated individually to a connected sensor. The alarm thresholds and the hysteresis can be freely adjusted.

New: It is possible to set an alarm delay for each alarm relay so that the relay is just triggered after that period of time.



Accessories FA 500/510/515



DESCRIPTION	ORDER-NO.
Diffusion-tight PTFE hose 6 mm with quick-release coupling length 1m	0554 0003
Diffusion-tight PTFE hose 6 mm, length 1m	0554 0008



DESCRIPTION	ORDER-NO.
Cooling section made of stainless steel	0699 3291

- 6 mm stainless steel tube wound as a spiral.
- With the cooling section, process gases from ovens etc. can be cooled from high temperatures (about 900°C) to a sensor-compatible temperature of about 50°C. Condensation of the dew point to be avoided.

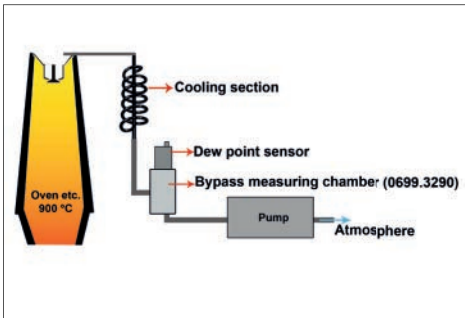

DESCRIPTION	ORDER-NO.
Quick-lock coupling NW 7,2 - G 1/2" male thread	0530 1101



DESCRIPTION	ORDER-NO.
Control and calibration set 11,3 %RH	0554 0002
Control and calibration set 33 %RH	0554 0004
Control and calibration set 75,3 %RH	0554 0005

- Control and calibration sets provide a defined humidity over a saturated saline solution
- The control and calibration set is screwed onto the dew point sensor and thus enables a simple and inexpensive control and calibration option down to -20° Ctd dew point on site

Accessories FA 500/510/515



DESCRIPTION	ORDER-NO.
Dry container for CS dew point sensors	0669 2500

- Provides sensor protection and fast equalization time. Recommended for storage of mobile sensors

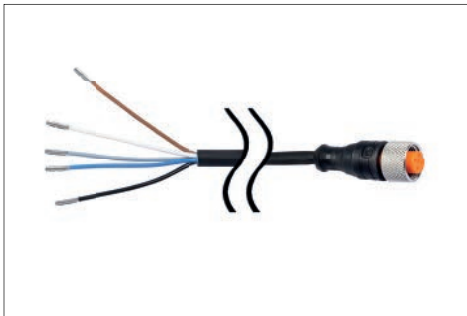

DESCRIPTION	ORDER-NO.
Connection cable for VA / FA series, 5 m	0553 0104
Connection cable for VA / FA series, 10 m	0553 0105
Connection cable for VA / FA series, 5 m shielded	0553 0129
Connection cable for VA / FA series, 10 m shielded	0553 0130
Cable for alarm/pulse output, with M12 plug, 5 m	0553 0106
Cable for alarm/pulse output, with M12 plug, 10 m	0553 0107



DESCRIPTION	ORDER-NO.
M12 plug for FA 500/510/515	0 2000 0082
M12 plug angled 90°	0219 0060



DESCRIPTION	ORDER-NO.
Adapter plug FA 515/Michell easidew valve plug DIN 43650 shape C 8 mm	0 2000 1389



DESCRIPTION	ORDER-NO.
Ethernet connection cable length 5 m, M12 plug x-coded (8 pol.) on RJ 45 plug	0553 2503
Ethernet connection cable length 10 m, M12 plug x-coded (8 pol.) on RJ 45 plug	0553 2504



Accessories FA 550

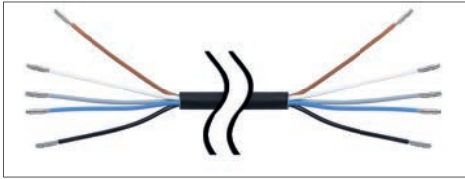

DESCRIPTION	ORDER-NO.
Connection cable 5 m with open ends	0553 0108
Connection cable 10 m with open ends	0553 0109



DESCRIPTION	ORDER-NO.
PNG screwed cable fitting - for standard	0553 0552

Accessories for all FA 5xx



DESCRIPTION	ORDER-NO.
Mains unit in wall housing for max. 2 sensors of the VA/FA 5xx series 100-240 V, 23 VA, 50-60 Hz / 24 VDC, 0,35 A	0554 0110



DESCRIPTION	ORDER-NO.
Power supply unit 100-240 V AC/24 V for VA/FA 5xx	0554 0109

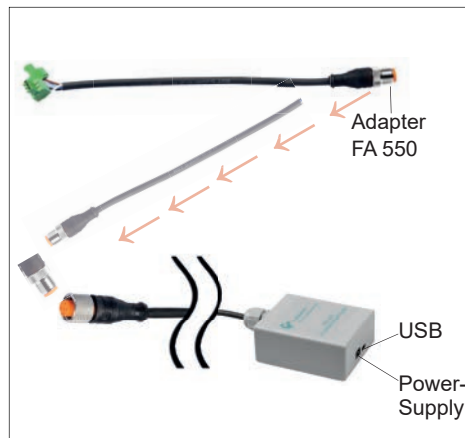

DESCRIPTION	ORDER-NO.
CS service software incl. PC connection set, USB port and Interface adapter to the sensor	0554 2007

Measuring chambers



DESCRIPTION	ORDER-NO.
Standard measuring chamber for compressed air	0699 3390

- Applicable for 2...16 bar
- Process connection: Plug nipple NW 7.2 (Parker series 26) or G1 / 4 „female thread when used without plug nipple
- Sensor connection: G 1/2“ female thread
- Gives 2-3 liters / min of process air to the environment
- The copper capillary relaxes the compressed air and prevents the backflow of moisture from the ambient air into the measuring chamber



DESCRIPTION	ORDER-NO.
Stainless steel measuring chamber for compressed air up to 50 bar	0699 3292

- Applicable for 2...50 bar
- Process connection: G 1/4" female thread
- Sensor connection: G 1/2" female thread
- Gives 2-3 liters / min of process air to the environment



DESCRIPTION	ORDER-NO.
Stainless steel measuring chamber for compressed air up to 50 bar with NPT thread	0699 3293

- Process connection: G 1/4" female thread
- Sensor connection: 5/8" UNF female thread
- Applicable for 2 ... 50 bar
- Gives 2-3 liters / min of process air to the environment via a fine nozzle



DESCRIPTION	ORDER-NO.
High pressure measuring chamber for compressed air up to 350 bar	0699 3590

- Applicable for 30...350 bar
- Process connection: G 1/4" female thread
- Sensor connection: G 1/2" female thread
- Gives 2-3 liters / min of process air to the environment via a fine nozzle
- Via the high-pressure valve, the amount of air for sampling can be adjusted individually depending on the pressure level. The process air is released to the environment via the sinter filter



DESCRIPTION	ORDER-NO.
Stainless steel bypass measuring chamber for dew point measurement in gases under pressure	0699 3290

- Applicable for -1...350 bar
- Process connection: G 1/4" female thread gas inlet and G 1/4" female thread gas outlet
- Sensor connection: G 1/2" female thread
- The flow of at least 2 liters / min of gas must be ensured by the customer



Measuring chambers

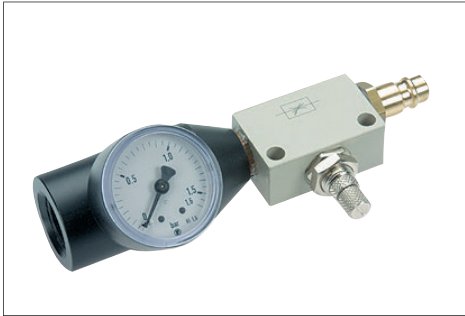

DESCRIPTION	ORDER-NO.
Measuring chamber for atmospheric dew point	0699 3690

- Applicable for 2...16 bar
- Process connection: Plug nipple NW 7.2 (Parker series 26) or G 1/4" female thread when using without plug nipple
- Sensor connection: G 1/2" female thread
- Gives 2-3 liters / min of process air to the environment
- The throttle valve in front of the measuring chamber relaxes the compressed air to atmospheric pressure in the measuring chamber. The manometer integrated in the measuring chamber indicates the overpressure to the atmosphere



DESCRIPTION	ORDER-NO.
Measuring chamber for granulate dryers and gases	0699 3490

- Applicable for -1...16 bar
- Process connection: Plug connection for 6 mm hose at inlet and outlet or G 1/4" female thread when using without plug connections
- Sensor connection G 1/2" female thread
- The flow of at least 2 liters / min of air / gas must be ensured by the customer



Calibration of dew point sensors

The calibration range for dew point sensors are $-80^{\circ}\text{Ctd} \dots 20^{\circ}\text{Ctd}$

Both dew point sensors from us and from other manufacturers can be calibrated. High precision reference measuring instruments with DKD resp. BAM certificate grant an accuracy of up to 0.1°C dew point.

Special feature:

Due to the digital data transmission, only the dew point sensor has to be calibrated. The display devices remain wired on site.



Calibration range: from -80 to 20°Ctd -
Accuracy of the DKD reference: $0,1^{\circ}\text{Ctd}$



Control and calibration set

Control and calibration sets guarantee a defined humidity by means of a saturated saline solution.

The control and calibration set is screwed onto the dew point sensor and therefore enables an easy and low-priced possibility for on-site control and calibration down to -20°C dew point.

DESCRIPTION	ORDER-NO.
Recalibration and precision calibration at -40°Ctd or 3°Ctd including ISO-Certifikate	0699 3333
Precision calibration in the range $-80\dots 20^{\circ}\text{Ctd}$, $^{\circ}\text{Ctd}$ points freely selectable	0700 7710
Control and calibration set 11.3 %RH	0554 0002
Control and calibration set 33 %RH	0554 0004
Control and calibration set 75.3 %RH	0554 0005
Precision calibration at -40°Ctd or 3°Ctd including ISO certificate	0699 3396
Replacement unit for the period of re-calibration	0699 3900
Dew point sensor in exchange with calibration certificate at -40°Ctd	0699 3990

CS Service Software

With the CS service software including the USB - Modbus interface adapter, the FA 510 / FA 515 / FA 500 dew point sensors can be configured via laptop / PC. The following settings can be made via CS Service Software:



- Scaling of the 4...20 mA analogue output
- Assignment of the measured variable to the analogue output (e.g. 4...20 mA = 0...10 g/m³)
- Available units: °Ctd, °Ftd, g/m³, mg/m³, ppmv/v, g/kg
- Reading out the firmware version, serial number, date of the last calibration
- One-point calibration (adjustment) of the sensors in the process. This requires a reference device
- Update of the sensor software (Firmware)
- Modbus settings as Modbus-ID, Baud rate, Stopbit, Parity

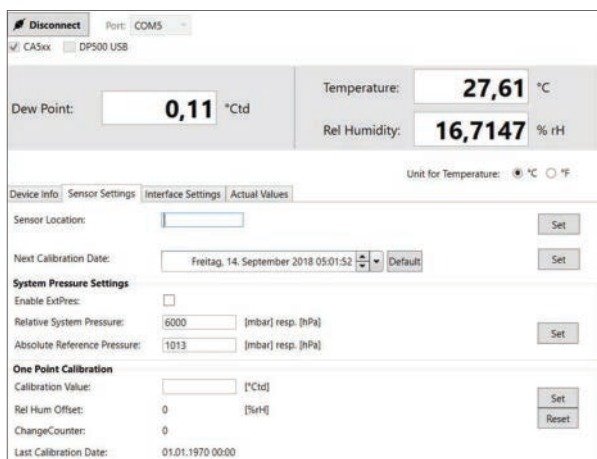
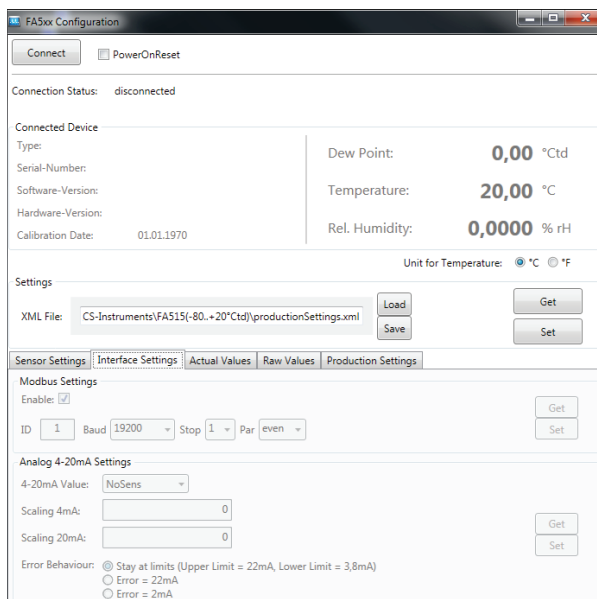

DESCRIPTION	ORDER-NO.
CS Service Software incl. PC connection set, USB connection and interface adapter to the sensor	0554 2007



Dew point measurement in compressed air plants

Today, compressed air is an essential and reliable source of energy from modern production processes.

Depending on the particular application, different requirements are made on the compressed air. The observance of a specific moisture content or dew point/pressure dew point is the basic prerequisite for a permanently trouble-free plant operation for every process.

Especially for moisture measurement or dew point / pressure dew point measurement in compressed air and gases, we have developed the DS 400 measuring device with many new advantages.



Usually compressed air is made from ambient air by using piston or screw compressors and which then has to be dried more or less strongly.

The aim is to produce dry, oil-free and dust particle poor compressed air with the smallest possible efforts. Residual oil and dust particles can be removed by means of complex filter systems.

However, moisture has to be reduced by means of dryers (refrigeration dryers, membrane driers, desiccant dryers and so on) which ideally work independent from any load.

How does water get into compressed air?

Air is able to bind more water vapor if the temperature is higher and the volume is bigger. In contrary case it has only a poor capacity to bind water vapor if the air is compressed.

A compressor compresses atmospheric ambient air into a fraction of its original volume. At a certain point of the compression process the water content of the air exceeds the decreasing ability of the air to bind water. The air is saturated and part of the water drops out as condensate.

By means of an additional decrease of the temperature even more water will condensate. This means that the relative humidity at the end of a compressor will always be at 100 % and that there will be additional water drops in the exit air.

The amount of liquid which drops out under pressure can be large. For example a 30 kW compressor releases approximately 20 liters into the compressed air line at a humidity of 60 % and an ambient temperature of 20 °C.

In case of big compressors this value will be much higher.

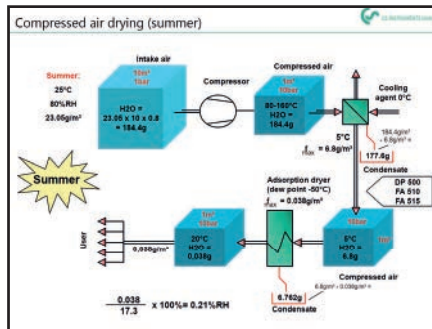

Effects of the moisture content

Depending on the application different demands are made on the compressed air. For each process the observance of a certain moisture content is the condition for a durably failure-free functioning of the whole system.

Most of the compressed air lines are made from steel or non zinc-coated steel. Since the corrosion speed strongly increases from a relative humidity of 50 % this value should be exceeded in no case. In the course of time, high moisture will lead to a corrosion in case of non zinc-coated lines.

The rust gradually chips off and moves to the sampling points. This leads e. g. to blocked nozzles, defective control elements and production stops.

Expensive repairs and short maintenance intervals are inevitable.

In addition to problems with corrosion and the described results the moisture content has direct influence on the quality of the final products.

Which problems may arise in case of too high moisture?

In the following please find some of the most occurring samples:

- Hygroscopic products (spices, sugar and so on) agglutinate during transportation through the pneumatic conveying system
- Bubbles occur during varnishing and coating processes
- Drilled holes may get blocked due to dust which is carried along
- In winter control valves freeze in unheated halls

Recommended compressed air qualities				
Application	Compressed air quality classes according to DIN ISO 8573-1			
	Particle		Residual flow	
	Class	µm	Class	Dew Point
Respiration air	1	0.1	1-3	-70/-20 °C
Spray guns	1	0.1	2	-40 °C
Medical technology	1	0.1	3-4	-20/+3 °C
Measurement and control techs.	1	0.1	4	+3 °C
Transportation of food and beverages	2	1	3	-20 °C
Sand blasting plants	-	-	4-3	+3/-20 °C
General factory air	3	5	4	+3 °C
Break-up hammer	4	15	5-4	+7/+3 °C

Task of dryers

Differently types of dryers are used in practice in order to control the problems of too high moisture. In compressed air technology the pressure dew point is the parameter for indicating the dryness of compressed air.

The pressure dew point is the temperature at which the moisture which is contained in the compressed air condenses to liquid water (also saturation, 100 % relative humidity).

The lower the pressure dew point temperature the smaller is the amount of water vapor contained in the compressed air.

Refrigeration dryers for dew point values around + 2 °Ctd

There are different types of compressed air dryers; refrigeration dryers or desiccant dryers are the most commonly used ones.

Refrigeration dryers cool down the compressed air to approximately 2 to 5 °C. In this case the pressure dew point is also 2 to 5 °C. The excess water vapor condenses and drops out.



After that the air is again heated up to room temperature.

The refrigeration compressed air dryers are monitored in most cases only by an indication of the cooling temperature. Only in large plants or in particularly important applications a stationary humidity monitoring is installed.

However, only the display of the cooling temperature is not sufficient. Even if the cooling temperature seems to be well, the following errors can lead to an excessive pressure dew point:

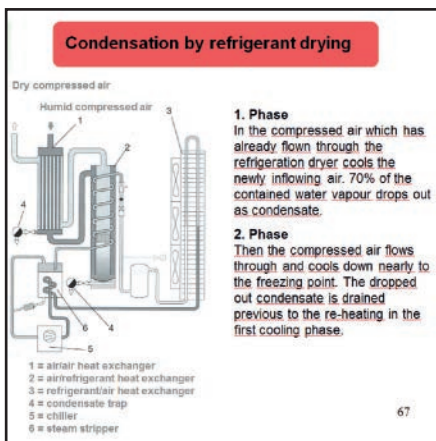

- **Condensate in the refrigeration dryer is not drained off (condensate drain defective resp. soiled)**
- **Compressed air bypass in the refrigeration dryer (heat exchanger pipes worn out, corroded and so on)**
- **Compressed air bypass in the bypass line (wet compressed air passes the bypass instead of passing the dryer)**
- **Condensate overload of the refrigeration dryer due to poor condensate pre-separation**

If the refrigeration dryer fails this inevitably leads to considerable problems with condensate in the compressed air line. It is especially problematic (besides the already listed problems) if the condensate can concentrate in blind lines and does not drain automatically.

Condensate in blind lines can only be removed by means of considerable efforts or dried and drained off by means of an extremely large amount of compressed air.

This often leads to increased dew point values at very low consumptions without any avoidable problems of the refrigeration dryer.

In this case it is quite difficult for the person who is responsible for compressed air to find out in the long-term the reason for the increased dew point values or in the extreme case for the condensate

Desiccant driers for typical dew points around -30...-40°Ctd

The functioning of the desiccant dryer is based on the principle of the attraction between the two masses. Water vapor is bound (adsorbed) at the surface of a desiccant.

Effective desiccant driers are able to dry compressed air down to a dew point of -40°C and lower.

Regenerative desiccant driers exist of two tanks which are filled with desiccant. In different procedures there is one tank regenerated cold resp. warm while the other one dries the operation air.

Depending on the procedure and the operating conditions the desiccant has to be exchanged in cycles of three to five years. Certain operating conditions lead to a shortening of the life span of the desiccant:

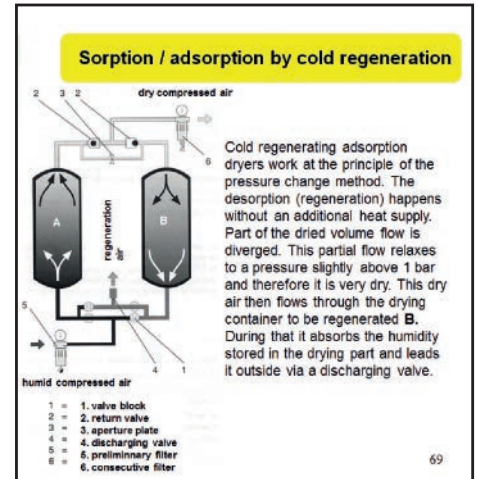

- **Overload due to too big compressed air consumption**
- **Poor pre-separation of condensate**
- **Oily air**
- **Too long regeneration times of the single tanks**

New: DS 400 dew point measurement with alarm grants process safety

For a safe process procedure it is necessary to monitor the demanded pressure dew points at any time and to get an alarm in case of exceeding of the threshold values.

3.5" graphic display - easy operation with touch screen.

DS 400 dew point set

Worldwide unique with 3.5 inch graphic display with touch screen and print function.



DS 400 dew point sets for refrigeration driers as well as for membrane/desiccant driers down to $-80\text{ }^{\circ}\text{Ctd}$ can be monitored easily and safely. The dew point sets will be supplied completely wired, therefore a time consuming studying of the instruction manual is not necessary.

Exceeding of threshold values can be reported optically and acoustically. 2 relays for pre- and main alarm are freely adjustable.

An alarm delay can be set for each relay. This grants that only really long-term exceeding of the threshold values are indicated. Additionally every alarm can be reset.

The dew point set DS 400 consists of the multifunction measuring instrument DS 400 and the dew point sensor FA 510 including measuring chamber for pressure dew point measurement of compressed air and gases up to 16/50/350 bar. For pressures of more than 16 bar please use the high-pressure measuring chamber.

The heart of the dew point sensor is the worldwide proven humidity sensor. In order to get quick and accurate measurements it is necessary that the humidity sensor is continuously flown by the gas (compressed air) to be measured. For this purpose a defined volume flow is blown out at a certain pressure via a capillary line.

The measuring chamber can be connected to the sampling point without any large installation efforts by means of the standard plug nipple for compressed air lines.

The big difference to customary paperless chart recorders is reflected in the simplicity of DS 400 on initiation and evaluation of the measured data.

The intuitive operation with the 3.5 inch touch screen graphic display with zoom function and print key is **worldwide unique in this price class.**

By means of the graphic display with zoom function the drying procedure resp. the dew point curve can be seen at a glance and stored in the data logger.

So the user can take a look at the stored measuring curves also without any computer at any time on site. This grants a quick and easy analysis of the drying behavior.

By means of the print key the actual screen can be stored as an image file to the internal SD card or to a USB stick and printed out at the computer without any additional software.

Ideal for documentation of the measured values/ curves on site. Colored measured curves can be sent by e-mail as image files or integrated into a service report.

The internal data logger enables the storage of the measured data for several years. The measured data can be evaluated via a USB stick or via Ethernet by means of the comfortable software CS Soft Basic.

Special features:

- 3.5" graphic display, intuitive operation via touch screen
- Zoom function for accurate analysis of measured values
- Colored measured curves with names
- Mathematical calculation function for calculation of the dew
- Point distance (condensate switch)
- Print key: Optional indications can be stored as image
- Files directly on a USB stick and sent by e-mail
- Without any software
- 2 alarm contacts for exceeding of threshold values
- Freely adjustable alarm delay for both alarm contacts with reset function
- Up to 4 sensor inputs for: Further flow sensors, dew point, pressure, temperature, consumption, active power meters, optional third-party sensors can be connected: Pt100/1000, 0/4..20 mA, 0-1/10 V, Modbus, pulse
- Integrated data logger 8 GB
- USB, Ethernet interface, RS 485
- Webservice

VA 570 - Inline flow meter



Flange version

**Version with pipe thread
R thread or NPT thread**

VA 570 is supplied with an integrated measuring section. The measuring sections are available in flanged version or with R resp. NPT thread.

A special feature is the removable measuring head. So the measuring unit can be removed easily and quickly for calibration or cleaning purposes without having to dismount the measuring section intricately. During this period the measuring section is sealed by a closing cap (accessory).

The screwing with centering device ensures that the sensor is positioned accurately in the center when screwing it into the measuring section furthermore it grants an exact positioning in the flow direction. This avoids unnecessary measuring faults.

Special measurement technology features:

- 4 values in the display: Flow, total consumption, velocity, temperature. Units freely adjustable
- All measured values, settings like gas type, inner diameter, serial number and so on retrievable via Modbus RTU
- Comprehensive diagnosis functions readable at the display or remote access via Modbus like e. g. exceeding of max/min values °C, calibration cycle, error codes, serial number
- Notification in case of exceeding of the calibration cycle
- Standard version accuracy 1.5 % of m.v. ± 0.3 % of f.s.
- Precision version accuracy 1.0 % of m.v. ± 0.3 % of f.s.
- Measuring span of 1 : 1000 (0.1 up to 224 m/s)
- Configuration and diagnosis via display, hand-held instrument PI 500, PC service software on-site
- Gas type (air, nitrogen, oxygen, argon and so on) freely adjustable via PC service software or external device DS 400, DS 500, PI 500
- Reference conditions °C and mbar/hPa freely adjustable
- Zero-point adjustment, leak flow volume suppression
- Pressure loss negligible

Special mechanical features:

- Robust impact-proof aluminum die cast housing for the outdoor area IP 67
- All medium-touching parts made from stainless steel 1,4571
- On request with ATEX approval ATEX II 2G Ex d IIC T4 (up to 120 °C)
- On request with DVGW approval for natural gas (up to 16 bar)
- Pressure rang up to 16 bar, special version up to 40 bar
- Temperature range up to 180 °C
- No moving parts, no wear out
- Sensor tip very robust, easy to clean
- Housing turnable, display turnable by 180°

Measuring range - Flow VA 570

		1/2"	3/4"	1"	1 1/4"	1 1/2"	2"	2 1/2"	3"
		m³/h (cfm)	m³/h (cfm)	m³/h (cfm)	m³/h (cfm)	m³/h (cfm)	m³/h (cfm)	m³/h (cfm)	m³/h (cfm)
Reference conditions DIN 1945 / ISO 1217: 20 °C, 1000 mbar									
Air	Low-Speed (50 m/s)	20 (14)	45 (25)	75 (45)	140 (80)	195 (115)	320 (190)	550 (325)	765 (450)
	Standard (92,7 m/s)	45 (25)	85 (50)	145 (85)	265 (155)	365 (215)	600 (350)	1025 (600)	1420 (835)
	Max (185 m/s)	90 (50)	175 (100)	290 (170)	530 (310)	730 (430)	1195 (700)	2050 (1205)	2840 (1670)
	High-Speed (224 m/s)	110(60)	215 (125)	355 (210)	640 (375)	885 (520)	1450 (850)	2480 (1460)	3440 (2025)
Adjustment to DIN 1343: 0 °C, 1013.25 mbar									
Argon (Ar)	Low-Speed (50 m/s)	35 (20)	75 (40)	120 (70)	220 (130)	305 (180)	505 (295)	865 (510)	1200 (705)
	Standard (92,7 m/s)	70 (40)	135 (80)	230 (135)	415 (245)	570 (335)	935 (550)	1605 (945)	2225 (1310)
	Max (185 m/s)	140 (80)	275 (160)	460 (270)	830 (485)	1140 (670)	1870 (1100)	3205 (1885)	4440 (2615)
	High-Speed (224 m/s)	170 (100)	335 (195)	555 (325)	1005 (590)	1385 (815)	2265 (1330)	3880 (2285)	5380 (3165)
Carbondi-oxide (CO2)	Low-Speed (50 m/s)	20 (14)	45 (25)	75 (45)	140 (80)	195 (115)	320 (185)	545 (320)	760 (445)
	Standard (92,7 m/s)	45 (25)	85 (50)	145 (85)	260 (155)	360 (210)	590 (345)	1015 (595)	1405 (825)
	Max (185 m/s)	90 (50)	175 (100)	290 (170)	525 (305)	720 (425)	1185 (695)	2030 (1190)	2810 (1655)
	High-Speed (224 m/s)	105 (60)	210 (125)	350 (205)	635 (370)	875 (515)	1430 (840)	2455 (1445)	3405 (2000)
Nirogen (N2)	Low-Speed (50 m/s)	20 (13)	40 (25)	70 (40)	130 (75)	180 (105)	295 (175)	505 (300)	705 (415)
	Standard (92,7 m/s)	40 (20)	80 (45)	135 (75)	240 (140)	335 (195)	550 (320)	945 (555)	1305 (770)
	Max (185 m/s)	80 (45)	160 (95)	270 (155)	485 (285)	670 (395)	1100 (645)	1885 (1110)	2610 (1535)
	High-Speed (224 m/s)	100 (55)	195 (115)	325 (190)	590 (345)	815 (475)	1330 (780)	2280 (1340)	3165 (1860)
Oxygen (O2)	Low-Speed (50 m/s)	20 (13)	45 (25)	75 (40)	135 (80)	185 (110)	305 (180)	525 (310)	730 (430)
	Standard (92,7 m/s)	40 (25)	80 (45)	140 (80)	250 (145)	345 (205)	570 (335)	980 (575)	1355 (795)
	Max (185 m/s)	85 (50)	165 (95)	280 (165)	505 (295)	695 (410)	1140 (670)	1955 (1150)	2710 (1590)
	High-Speed (224 m/s)	105 (60)	205 (120)	340 (200)	610 (360)	845 (495)	1380 (810)	2365 (1390)	3280 (1930)
Nitrous Oxide (N2O)	Low-Speed (50 m/s)	20 (14)	45 (25)	75 (45)	140 (80)	190 (110)	315 (185)	540 (320)	750 (440)
	Standard (92,7 m/s)	40 (25)	85 (50)	140 (85)	260 (150)	355 (210)	585 (345)	1005 (590)	1395 (820)
	Max (185 m/s)	85 (50)	170 (100)	285 (170)	520 (305)	715 (420)	1170 (690)	2010 (1180)	2785 (1640)
	High-Speed (224 m/s)	105 (60)	210 (120)	345 (205)	630 (370)	865 (510)	1420 (835)	2435 (1430)	3375 (1985)
Natural gas (NG)	Low-Speed (50 m/s)	14,4 (8)	25 (15)	45 (25)	85 (50)	115 (65)	190 (110)	325 (190)	450 (265)
	Standard (92,7 m/s)	25 (15)	50 (30)	85 (50)	155 (90)	215 (125)	355 (205)	605 (355)	840 (495)
	Max (185 m/s)	50 (30)	105 (60)	170 (100)	310 (185)	430 (250)	705 (415)	1210 (710)	1680 (985)
	High-Speed (224 m/s)	65 (35)	125 (70)	210 (120)	380 (220)	520 (305)	855 (500)	1465 (865)	2035 (1195)



Optional: Connection to different Bus systems

There are different options available for connection to modern Bus systems:

- Ethernet interface (Modbus-TCP) / PoE
- M-BUS
- Modbus-RTU
- Profibus DP interface (in processing)
- Profinet interface (in processing)
- HART (in processing)



Ethernet Modbus-TCP

M12 Ethernet Port, x-coded

HART

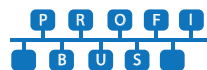

M-Bus

Further accessories see pages 82 to 86

VA 570 - Inline flow sensor

Example order code VA 570:

0695 0570_A1_B1_C1_D1_E1_F1_G1_H1_I1_J1_K1_L1_M1_R1

Outer thread measuring section	
A1	R outer thread
A2	NPT outer thread
A3	Flange version DIN EN 1092-1
A4	Flange ANSI 16.5 Class 150 lbs
A5	Flange ANSI 16.5 Class 300 lbs

Option display	
B1	with integrated display
B2	without display

Option signal output / Bus connection	
C1	2 x 4...20 mA analog output galv. isolated, pulse output RS 485 (Modbus-RTU)
C2	Profibus DP, 2 x 4...20 mA analog output galv. isolated, pulse output RS 485 (Modbus-RTU)
C4	1 x 4...20mA analog output not galvanically isolated, pulse output, RS485 (Modbus RTU)
C5	Ethernet-Interface (Modbus/TCP), 1 x 4...20 mA analog output (not galvanically isolated), pulse output, RS 485 (Modbus-RTU)
C8	M-Bus, 1 x 4 ... 20 mA analog output (not electrically isolated), pulse output, RS 485 (Modbus-RTU)
C9	Ethernet-Interface PoE (Power over Ethernet) (Modbus/TCP), 1 x 4...20 mA analog output (not galvanically isolated), pulse output, RS 485 (Modbus-RTU)

Calibration	
D1	no real gas calibration - gas adjustment via gas constant
D2	real gas calibration in the gas type as selected below

Gas type	
E1	Compressed air
E2	Nitrogen (N2)
E3	Argon (Ar)
E4	Carbon dioxide (CO2)
E5	Oxygen (O2)
E6	Nitrous oxide (N2O)
E7	Natural gas (NG)
E8	Helium (He)
E9	Propane (C3H8)
E10	Methane (CH4)
E11	Biogas (Methan 50% : CO2 50%)
E12	Hydrogen (H2)
E90	Further gas / please indicate gas type (on request)
E91	Gas mixture / please indicate mixture ratio (on request)

Reference conditions	
F1	20°C, 1000 hPa
F2	0°C, 1013,25 hPa
F3	15°C, 981 hPa
F4	15°C, 1013,25 hPa

Maximum pressure	
G1	16 bar
G2	40 bar

Surface condition	
H1	standard version
H2	special cleaning - oil and grease free (e. g. for oxygen applications and so on)
H3	Silicone free version including special cleaning oil and grease free

Accuracy class	
I1	± 1,5% of measure value ± 0,3% of f.s.(standard)
I2	± 1% of measure ± 0,3% of f.s. (precision)

Maximum gas temperature at the sensor tip	
J1	up to 120°C gas temperature (only for ATEX version)
J2	up to 180°C gas temperature (standard version)

Approvals	
K1	Non-explosive area - no approval
K2	ATEX II 2G Ex d IIC T4
K3	DVGW approval for natural gas (maximum pressure 16 bar)

Measuring range (see table)	
M1	Max version (185 m/s)
M2	Low speed version (50 m/s)
M3	Standard version (92,7 m/s)
M4	High Speed version (224 m/s)

Special measuring range	
R1	Special measuring range (Please indicate in case of order)

Order no. VA 570

DESCRIPTION	ORDER-NO.	TECHNICAL DATA VA 570
VA 570 flow meter with integrated 1/2" measuring section	0695 0570 + order code A...R_	Measuring range VA 570: up to 50 Nm/s, Low Speed version* up to 92,7 Nm/s, Standard version* up to 185 Nm/s, Max version* up to 224 Nm/s, High Speed version* * Measuring range Nm ³ / h for different pipe diameters and gases, see table measuring ranges flow * All measurements related to DIN 1343 standard conditions 0 ° and 1013 mbar ex works
VA 570 flow meter with integrated 3/4" measuring section	0695 0571	
VA 570 flow meter with integrated 1" measuring section	0695 0572	
VA 570 flow meter with integrated 1 1/4" measuring section	0695 0573	
VA 570 flow meter with integrated 1 1/2" measuring section	0695 0574	
VA 570 flow meter with integrated 2" measuring section	0695 0575	
VA 570 flow meter with integrated DN 15 measuring section with flange	0695 2570	
VA 570 flow meter with integrated DN 20 measuring section with flange	0695 2571	
VA 570 flow meter with integrated DN 25 measuring section with flange	0695 2572	
VA 570 flow meter with integrated DN 32 measuring section with flange	0695 2573	
VA 570 flow meter with integrated DN 40 measuring section with flange	0695 2574	
VA 570 flow meter with integrated DN 50 measuring section with flange	0695 2575	
VA 570 flow meter with integrated DN 65 measuring section with flange	0695 2576	
VA 570 flow meter with integrated DN 80 measuring section with flange	0695 2577	
Further accessories:		Accuracy: ± 1.5 % of m.v. ± 0.3 % of f.s. accuracy class <u>on request</u> (m.v.: of meas. value) ± 1.0 % of m.v. ± 0.3 % of f.s. (f.s.: of full scale) Accuracy indications: referred to ambient temperature 22 °C ± 2°C, system pressure 6 bar Repeatability: 0.25 % of m.v. in case of correct mounting (mounting aid, position, inlet section) Measuring principle: Thermal mass flow sensor Response time: t90 < 3 s Operating temperature range probe tube/display unit: -40...180 °C probe tube -40...70 °C display unit -40...120 °C for ATEX version Adjustment possibilities via display, external hand-held meter PI 500, PC Service Software, remote diagnosis: Nm ³ /h, Nm ³ /min, NI/min, l/s, ft/min, cfm, kg/h, kg/min, inside diameter, reference conditions ° C/° F, mbar/hPa, zero point correction, low flow cut off, scaling Analog output 4 ... 20 mA, pulse/alarm, error codes etc. Outputs: Standard: 1 x 4 ... 20 mA analog output (not electrically isolated), pulse output, RS 485 (Modbus RTU) Optional: 2 x 4 ... 20 mA active, Modbus TCP, HART, Profibus DP, Profinet, M-Bus Burden: < 500 Ohm Additional average value calculation: for all parameters freely adjustable from 1 minute up to 1 day, e. g. 1/2 hours average value, average day value Protection class : IP 67 Material: Housing aluminium die cast, probe tube stainless steel 1,4571 Operating pressure: 16 bar, in special version 40 bar Power supply: 18...36 VDC, 5 W Approval: ATEX II 2G Ex d IIC T4, DVGW
Closing cap for measuring section in aluminium	0190 0001	
Closing cap for measuring section stainless steel 1.4404	0190 0002	
Connection cable for sensors 5 m with open ends	0553 0108	
Connection cable for sensors 10 m with open ends	0553 0109	
Ethernet connection cable length 5 m, M12 plug x-coded (8 poles) to RJ 45 plug	0553 2503	
Ethernet connection cable length 10 m, M12 plug x-coded (8 poles) to RJ 45 plug	0553 2504	
Mains unit in wall housing for maximum 2 sensors of the series VA/FA 5xx, 100-240 V, 23 VA, 50-60 Hz / 24 VDC, 0.35 A	0554 0110	
ISO calibration certificate at 5 measuring points for VA sensors	3200 0001	
Additional calibration point for volume flow (point freely selectable)	0700 7720	
CS Service Software VA 550 incl. interface cable to PC (USB) and power supply - for configuration / parametrization of VA 550	0554 2007	
PNG cable screwing - standard VA 550/570	0553 0552	
PNG cable screwing – for ATEX version VA 550/570	0553 0551	

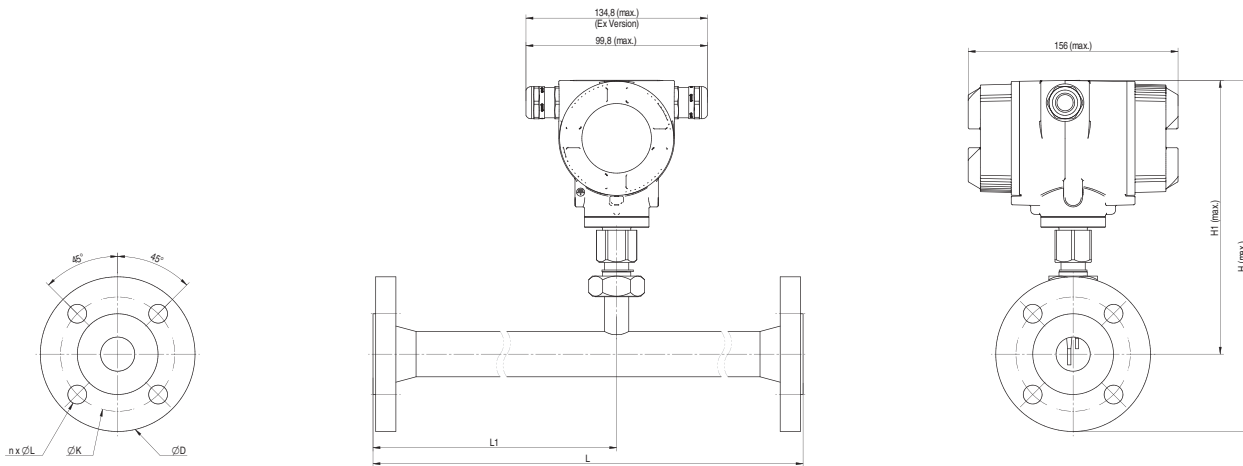

VA 570 - Flange version

Measuring section	Outer pipe diam. - mm	Inner pipe diam. - mm	L - mm	L1 - mm	H - mm	H1 - mm	Flange DIN EN 1092-1		
							Ø D	Ø K	n x Ø L
DN 15	21,3	16,1	300	210	213,2	165,7	95	65	4 x 14
DN 20	26,9	21,7	475	275	218,2	165,7	105	75	4 x 14
DN 25	33,7	27,3	475	275	223,2	165,7	115	85	4 x 14
DN 32	42,4	36,0	475	275	235,7	165,7	140	100	4 x 18
DN 40	48,3	41,9	475*	275	240,7	165,7	150	110	4 x 18
DN 50	60,3	53,1	475*	275	248,2	165,7	165	125	4 x 18
DN 65	76,1	68,9	475*	275	268,2	175,7	185	145	8 x 18
DN 80	88,9	80,9	475*	275	275,7	175,7	200	160	8 x 18

*Attention: Shortened inlet section. Please observe the recommended minimum inlet section (length = 15 x inner diameter)!

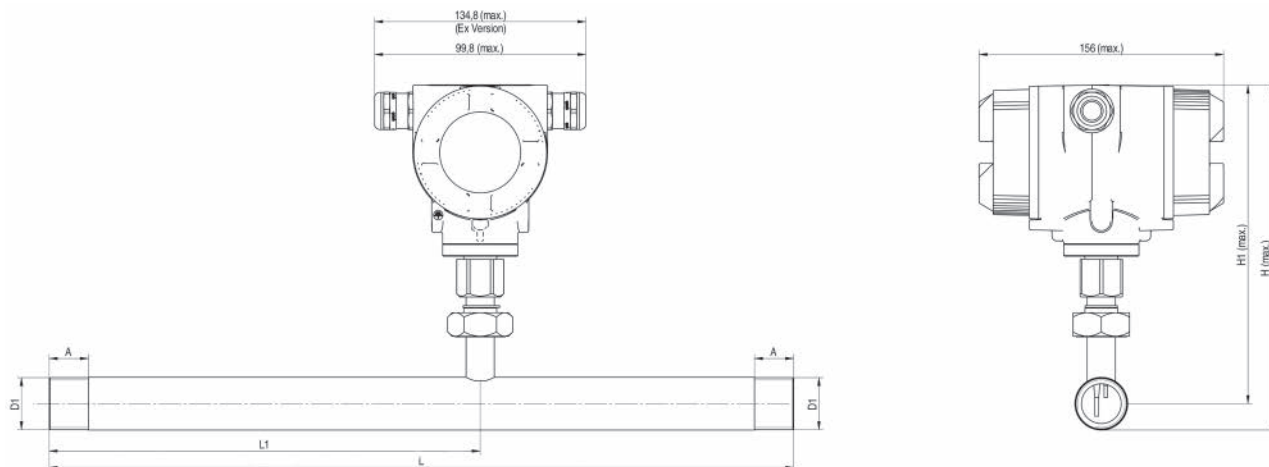

VA 570 - Threaded version

Connection thread	Outer pipe diam. - mm	Outer pipe diam.- mm	L - mm	L1 - mm	H - mm	H1 - mm	A - mm
R 1/2"	21,3	16,1	300	210	176,4	165,7	20
R 3/4"	26,9	21,7	475	275	179,2	165,7	20
R 1"	33,7	27,3	475	275	182,6	165,7	25
R 1 1/4"	42,4	36,0	475	275	186,9	165,7	25
R 1 1/2"	48,3	41,9	475*	275	186,9	165,7	25
R 2"	60,3	53,1	475*	275	195,9	165,7	30

*Attention: Shortened inlet section. Please observe the recommended minimum inlet section (length = 15 x inner diameter)!



Notes

VA 550 - Flow meter insertion type



Flow meter for installation in existing compressed air or gas pipes from 3/4" up to DN 1000

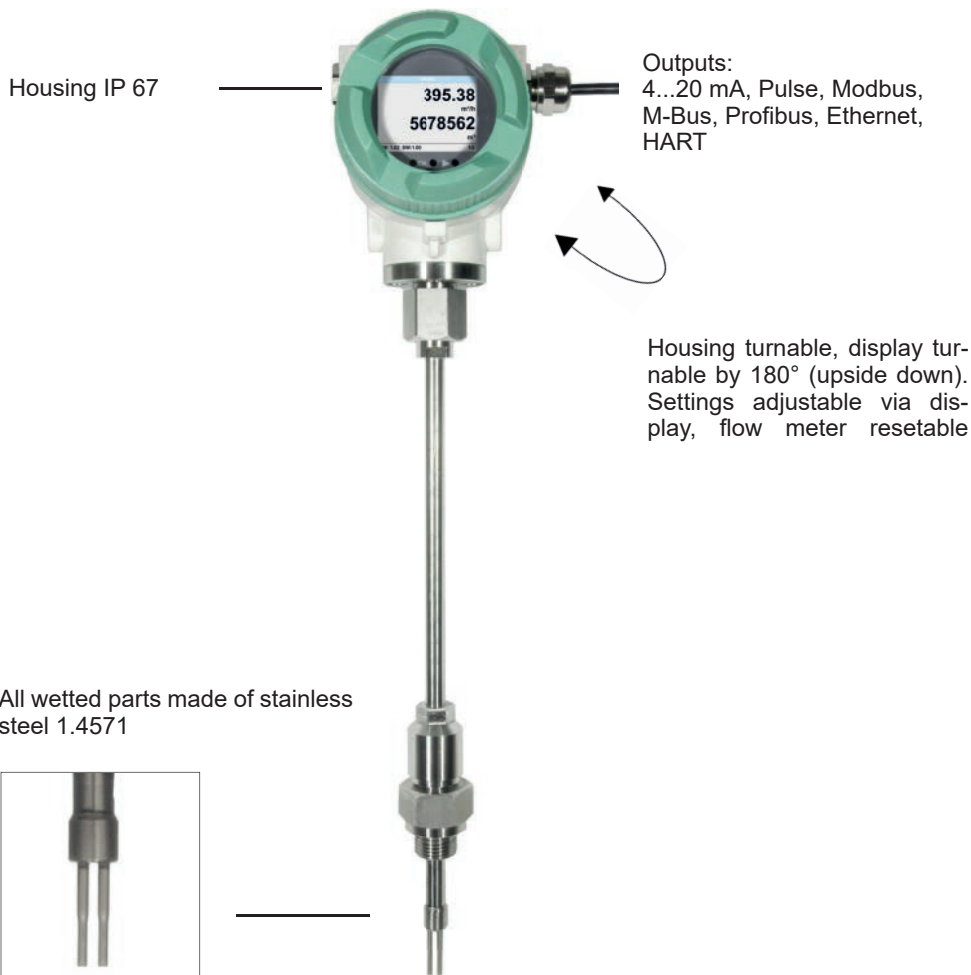

Advantages optical buttons:

The sensor can also be configured in the ATEX area without need to open the housing

Special measurement technology features:

- 4 values in the display: Flow, total consumption, velocity, temperature. Units freely adjustable
- All measured values, settings like gas type, inner diameter, serial number and so on retrievable via Modbus RTU
- Comprehensive diagnosis functions readable at the display or remote access via Modbus like e. g. exceeding of max/min values °C, calibration cycle, error codes, serial number
- Notification in case of exceeding of the calibration cycle
- Standard version accuracy 1.5 % of m.v. ± 0.3 % of f.s.
- Precision version accuracy 1.0 % of m.v. ± 0.3 % of f.s.
- Measuring span of 1 : 1000 (0.1 up to 224 m/s)
- Configuration and diagnosis via display, hand-held instrument PI 500, PC service software on-site
- Gas type (air, nitrogen, oxygen, argon and so on) freely adjustable via PC service software or external device DS 400, DS 500, PI 500
- Reference conditions °C and mbar/hPa freely adjustable
- Zero-point adjustment, leak flow volume suppression
- Pressure loss negligible

Special mechanical features:

- Robust impact-proof aluminum die cast housing for the outdoor area IP 67
- All medium-touching parts made from stainless steel 1,4571
- Suitable as a insertion version for 3/4" to DN 1000
- On request with ATEX approval ATEX II 2G Ex d IIC T4 (up to 120 °C)
- On request with DVGW approval for natural gas (up to 16 bar)
- Pressure range up to 50 bar, special version up to 100 bar
- Temperature range up to 180 °C
- No moving parts, no wear out
- Sensor tip very robust, easy to clean
- Easy installation and removal under pressure via 1/2" ball valve
- Housing turnable, display turnable by 180°
- Safety ring for installation and removal under pressure
- Depth scale for precise installation

Easy mounting/dismounting of VA 550 under pressure - without disconnection of the line - without emptying the line

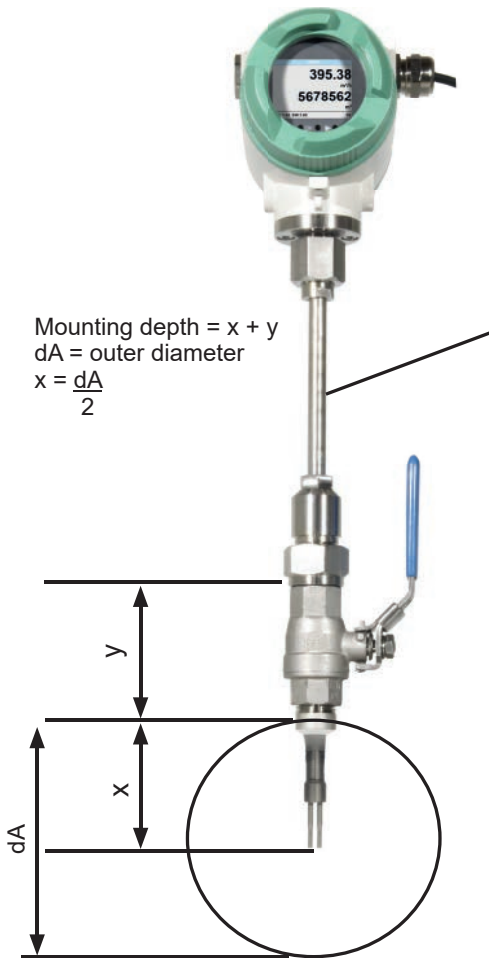

Mounting depth = $x + y$
 $dA =$ outer diameter
 $x = \frac{dA}{2}$

Engraved depth scale for precise installation

			180
			170
			160

If there is no suitable measuring site with 1/2" ball valve there are two simple possibilities to set up a measuring point:

A Weld on a 1/2" screw neck and screw on a 1/2" ball valve

B Mount spot drilling collar including ball valve

By means of the drilling jig it is possible to drill under pressure through the 1/2" ball valve into the existing pipeline. The drilling chips are collected in a filter. Then the sensor can be mounted.



A Screw neck

Order no.: 3300 0006



B Spot drilling collars

Order no.: see page 86



Drilling under pressure with CS drilling jig

Order no.: 0530 1108



Ethernet Modbus-TCP
 M12 Ethernet Port, x-coded

Optional: Connection to different Bus systems

There are different options available for connection to modern Bus systems:

- Ethernet interface (Modbus-TCP) / PoE
- M-BUS
- Modbus-RTU
- Profibus DP interface (in processing)
- Profinet interface (in processing)
- HART (in processing)

Further accessories see pages 82 to 86

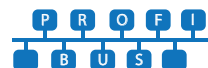

VA 550 - Flow meter insertion type

Example order code VA 550:

0695 0550_A1_B1_C1_D1_E1_F1_G1_H1_I1_J1_K1_L1_M1_R1

Measuring range (see table side 90 to 93)	
A1	Standard version (92,7 m/s)
A2	Max version (185 m/s)
A3	High Speed version (224 m/s)
A4	Low Speed version (50 m/s)

Screw-in thread	
B1	G 1/2" outer thread
B2	1/2" NPT outer thread
B3	PT 1/2" outer thread

Mounting length / shaft length	
C1	220 mm
C2	300 mm
C3	400 mm
C4	500 mm
C5	600 mm
C7	160 mm
C8	1000 mm

Option Display	
D1	with integrated display
D2	without display

Option signal outputs / bus connection	
E1	2 x 4...20 mA analog output galv. isolated, pulse output RS 485 (Modbus-RTU)
E2	Profibus DP, 2 x 4...20 mA analogue output galv. isolated, pulse output RS 485 (Modbus RTU)
E4	1 x 4...20mA analog output not galvanically isolated, pulse output RS485 (Modbus RTU)
E5	Ethernet-Interface (Modbus/TCP), 1 x 4...20 mA analog output (not galvanically isolated), pulse output, RS 485 (Modbus-RTU)
E7	2 x 4...20 mA analog output passive, pulse output RS 485 (Modbus-RTU)
E8	M-Bus, 1 x 4...20 mA analog output passive, pulse output RS 485 (Modbus-RTU)
E9	Ethernet-Interface PoE (Power over Ethernet) (Modbus/TCP), 1 x 4...20 mA analog output (not galvanically isolated), pulse output, RS 485 (Modbus-RTU)

Calibration	
F1	no real gas calibration - gas adjustment via gas constant
F2	real gas calibration in the gas type as selected below

Gas typ	
G1	Compressed air
G2	Nitrogen (N2)
G3	Argon (Ar)
G4	Carbon dioxide (CO2)
G5	Oxygen (O2)
G6	Nitrous oxide (N2O)
G7	Natural gas (NG)
G8	Helium (He)
G9	Propane (C3H8)
G10	Methane (CH4)
G11	Biogas (Methan 50% : CO2 50%)
G12	Hydrogen (H2)
G90	Further gas / please indicate gas type (on request)
G91	Gas mixture / please indicate mixture ratio (on request)

Maximum pressure (above 10 bar, please use high-pressure protection!)	
H1	50 bar
H2	100 bar
H3	16 bar

Surface condition	
I1	Standard version
I2	Special cleaning - oil and grease free (e.g. for oxygen applications and so on)
I3	Silicone free version including special cleaning oil and grease free

Accuracy class	
J1	± 1,5% of measured value (standard)
J2	± 1% of measured value (precision)

Maximum gas temperature at the sensor tip	
K1	up to 120 °C gas temperature (only for ATEX version)
K2	up to 180 °C gas temperature (standard version)

Approvals	
L1	Non-explosive area - no approval
L2	ATEX II 2G Ex d IIC T4
L3	DVGW approval for natural gas (maximum pressure 16 bar)

Reference conditions	
M1	20°C, 1000 hPa
M2	0°C, 1013,25 hPa
M3	15°C, 981 hPa
M4	15°C, 1013,25 hPa

Special measuring range	
R1	Special measuring range (Please indicate in case of order)

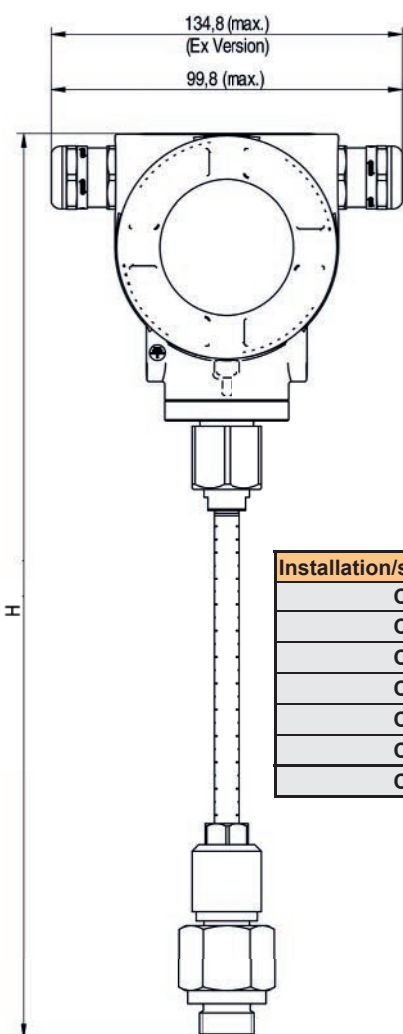

Installation/shaft length	L (mm)	H (mm)
C1	220	441
C2	300	521
C3	400	621
C4	500	721
C5	600	821
C7	160	381
C8	1000	1221

Order-no. VA 550

DESCRIPTION	ORDER-NO.
VA 550 flow meter, measuring head in robust die-cast aluminum housing	0695 0550 + order code A...R_

TECHNICAL DATA VA 550

Measuring range VA 550: up to 50 Nm/s, Low Speed version*
 up to 92,7 Nm/s, Standard version*
 up to 185 Nm/s, Max version*
 up to 224 Nm/s, High Speed version*

* Measuring range Nm³ / h for different pipe diameters and gases, see table measuring ranges flow
 * All measurements related to DIN 1343 standard conditions 0 ° and 1013 mbar ex works

Accuracy: ± 1.5 % of m.v. ± 0.3 % of f.s.
accuracy class on request
 (m.v.: of meas. value) ± 1.0 % of m.v. ± 0.3 % of f.s.
 (f.s.: of full scale)

Accuracy indications: referred to ambient temperature 22 °C ± 2 °C, system pressure 6 bar

Repeatability: 0.25 % of m.v. in case of correct mounting (mounting aid, position, inlet section)

Measuring principle: Thermal mass flow sensor

Response time: t90 < 3 s

Operating temperature range probe tube/display unit:
 -40...180 °C probe tube
 -40...70 °C display unit
 -40...120 °C for ATEX version

Adjustment possibilities via display, external hand-held meter PI 500, PC Service Software, remote diagnosis: Nm³/h, Nm³/min, NI/min, l/s, ft/min, cfm, kg/h, kg/min, inside diameter, reference conditions °C/°F, mbar/hPa, zero point correction, low flow cut off, scaling Analog output 4 ... 20 mA, pulse/alarm, error codes etc.

Outputs: **Standard:** 1 x 4 ... 20 mA analog output (not electrically isolated), pulse output, RS 485 (Modbus RTU)
Optional: 2 x 4 ... 20 mA active, Modbus TCP, HART, Profibus DP, Profinet, M-Bus

Burden: < 500 Ohm

Additional average value calculation: for all parameters freely adjustable from 1 minute up to 1 day, e. g. 1/2 hours average value, average day value

Protection class: IP 67

Material: Housing aluminium die cast, probe tube stainless steel 1,4571

Operating pressure VA 550: 50 bar; in special version 100 bar (with DVGW approval a maximum of 16 bar)

Power supply: 18...36 VDC, 5 W

Approval: ATEX II 2G Ex d IIC T4, DVGW

Further accessories:

DESCRIPTION	ORDER-NO.
Connection cable for sensors 5 m with open ends	0553 0108
Connection cable for sensors 10 m with open ends	0553 0109
Ethernet connection cable length 5 m, M12 plug x-coded (8 poles) to RJ 45 plug	0553 2503
Ethernet connection cable length 10 m, M12 plug x-coded (8 poles) to RJ 45 plug	0553 2504
Mains unit in wall housing for maximum 2 sensors of the series VA/FA 5xx, 100-240 V, 23 VA, 50-60 Hz / 24 VDC, 0.35 A	0554 0110
ISO calibration certificate at 5 measuring points for VA 500/550	3200 0001
Additional calibration point for volume flow (point freely selectable)	0700 7720
CS Service Software VA 550 incl. interface cable to PC (USB) and power supply - for configuration / parametrization of VA 550	0554 2007
High pressure protection for installation from 10 to 100 bar (for VA 550)	0530 1115
High pressure protection for installation from 10 to 16 bar DVGW (for VA 550)	0530 1116
PNG cable screwing - standard VA 550/570	0553 0552
PNG cable screwing - for ATEX version VA 550/570	0553 0551

VA 500 - Flow meter for compressed air and gases



Special advantages:

- Incl. temperature measurement
- RS 485 interface, Modbus-RTU as a standard
- Integrated display for m³/h and m³
- Usable from 1/2" to DN 1000
- Easy installation under pressure
- 4...20 mA analog output for m³/h resp. m³/min
- Pulse output for m³ or M-Bus (optional)
- Inner diameter adjustable via keypad
- Total counter resettable
- Adjustable via keys at the display: Reference conditions, °C and mbar, 4...20 mA scaling, pulse weight



Inner diameter adjustable via keypad



Option:
Bi-directional measurement. Blue or green arrows in the display indicate the flow direction. A meter reading is available for each flow direction.



DESCRIPTION	ORDER-NO.
VA 500 flow sensor in basic version: Standard (92.7 m/s), probe length 220 mm, without display	0695 5001
Bi-directional measurement - includes 2 x 4 ... 20 mA analog outputs and 2x pulse outputs. These are not available for Ethernet (PoE) and M-Bus interface	Z695 6000
Options for VA 500:	
Display	Z695 5000
Max version (185 m/s)	Z695 5003
High Speed version (224 m/s)	Z695 5002
Low speed version (50 m/s)	Z695 5008
1 % Accuracy of m.v. ± 0,3 % of f.s.	Z695 5005
Ethernet-Interface for VA500/520 and FA500	Z695 5006
Ethernet-Interface PoE for VA500/520 and FA500	Z695 5007
M-Bus board for VA500/520 and FA500	Z695 5004
Probe length 120 mm	ZSL 0120
Probe length 160 mm	ZSL 0160
Probe length 300 mm	ZSL 0300
Probe length 400 mm	ZSL 0400
Probe length 500 mm	ZSL 0500
Probe length 600 mm	ZSL 0600
ISO calibration certificate (5 calibration points) for VA sensors	3200 0001
Gas type: ____ (specify type of gas when ordering)	Z695 5009
Gas mixture: ____ (specify gas mixture when ordering)	Z695 5010
Real gas calibration	3200 0015
Special cleaning oil and grease-free (e. g. oxygen application)	0699 4005
Silicone-free version incl. cleaning free of oil and grease	0699 4007
Additional calibration curve stored in the sensor (selectable via display)	Z695 5011
Certificate of origin	Z695 0512

TECHNICAL DATA VA 500

Parameters:	m ³ /h, l/min (1000 mbar, 20 °C) in case of compressed air resp. Nm ³ /h, NI/min (1013 mbar, 0 °C) in case of gases
Units adjustable via keys at display:	m ³ /h, m ³ /min, l/min, l/s, ft/min, cfm, m/s, kg/h, kg/min, g/s, lb/min, lb/h
Adjustable via keypad:	Diameter for volume flow calculation, counter resettable
Sensor:	Thermal mass flow sensor
Measuring medium	Air, gases
Gas types are adjustable over CS service software or CS data logger:	Air, nitrogen, argon, helium, CO ₂ , oxygen, vacuum
Measure range:	See table page 75
Accuracy: (m.v.: of meas. value) (f.s.: of full scale)	± 1.5 % of m.v. ± 0.3 % of f.s. on request ± 1.0 % of m.v. ± 0.3 % of f.s.
Operating temperature:	-30...110 °C probe tube -30...80 °C housing
Operating pressure:	-1...50 bar
Digital output:	RS 485 interface (Modbus-RTU), Optional: Ethernet-Interface PoE), M-Bus
Analog output:	4...20 mA for m ³ /h e. g. l/min;
Pulse output:	1 Pulse per m ³ or per liter galvanically isolated. Pulse value can be set on the display. Alternatively, the pulse output can be used as an alarm relay
Supply:	18...36 VDC, 5 W
Burden:	< 500 Ω
Housing:	Polycarbonate (IP 65)
Probe tube:	Stainless steel, 1.4301 Mounting length 220 mm, Ø 10 mm
Mounting thread:	G 1/2"
Ø Casing:	65 mm
Mounting position:	any

Easy installation and removal under pressure

1) Even under pressure, the flow sensor VA 500 is mounted by means of a standard 1/2" ball valve. During mounting and dismantling the circlip ring avoids an uncontrolled ejection of the probe which may be caused by the operating pressure.

For the mounting into different pipe diameters VA 500 is available in the following probe lengths: 120, 160, 220, 300, 400 mm.

So the flow sensors are being mounted into existing pipelines with inner diameters of 1/2" upwards.

The exact positioning of the sensor in the middle of the pipe is granted by means of the engraved depth scale. The maximum mounting depth corresponds with the respective probe length. Example: VA 500 with probe length 220 mm has a maximum mounting depth of 220 mm.

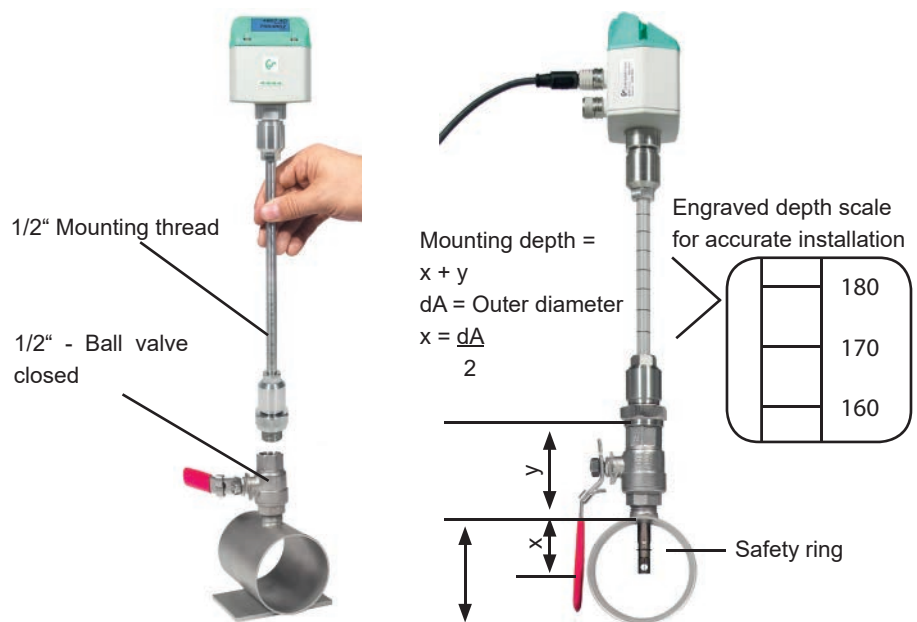

2) If there is no suitable measuring point with 1/2" ball valve, there are two easy ways to set up a measuring point:

A Weld on a 1/2" screw neck and screw on a 1/2" ball valve

B Mount spot drilling collar incl. ball valve (see accessories)

Drill holes can be drilled through the 1/2" ball valve into the existing tubing with the help of the drilling device, the drill chips are collected in a filter, then the probe is installed as described under 1).



A Screw neck



B Spot drilling collar



Drill under pressure with the CS Drill

3) Due to the large measuring range of the probe even extreme requirements to the flow measurement (high volume flow in small pipe diameters) can be met.

The measuring range is depending on the pipe diameter - see table on the right hand side.

Measuring ranges Flow VA 500 for compressed air (ISO 1217: 1000 mbar, 20°C)								
Measuring ranges for other types of gas see pages 90 to 93								
Inner diameter of pipe			VA 500 Standard (92,7 m/s)	VA 500 Max. (185,0 m/s)	VA 500 High Speed (224,0 m/s)			
Inch	mm		Measuring range		Measuring range		Measuring range	
			m³/h	(cfm)	m³/h	(cfm)	m³/h	(cfm)
1/2"	16,1	DN 15	759 l/min	26	1516 l/min	53	1836 l/min	64
3/4"	21,7	DN 20	89 m³/h	52	177 m³/h	104	215 m³/h	126
1"	27,3	DN 25	148 m³/h	86	294 m³/h	173	356 m³/h	210
1 1/4"	36,0	DN 32	266 m³/h	156	531 m³/h	312	643 m³/h	378
1 1/2"	41,9	DN 40	366 m³/h	215	732 m³/h	430	886 m³/h	521
2"	53,1	DN 50	600 m³/h	353	1197 m³/h	704	1450 m³/h	853
2 1/2"	68,9	DN 65	1028 m³/h	604	2051 m³/h	1207	2484 m³/h	1461
3"	80,9	DN 80	1424 m³/h	838	2842 m³/h	1672	3441 m³/h	2025
4"	110,0	DN 100	2644 m³/h	1556	5278 m³/h	3106	6391 m³/h	3761
5"	133,7	DN 125	3912 m³/h	2302	7808 m³/h	4594	9453 m³/h	5563
6"	159,3	DN 150	5560 m³/h	3272	11096 m³/h	6530	13436 m³/h	7907
8"	200,0	DN 200	8785 m³/h	5170	17533 m³/h	10318	21229 m³/h	12493
10"	250,0	DN 250	13744 m³/h	8088	27428 m³/h	16141	33211 m³/h	19544
12"	300,0	DN 300	19814 m³/h	11661	39544 m³/h	23271	47880 m³/h	28177

VA 520 - Inline flow meter

NEW: Modbus-RTU output

4...20 mA output for actual flow

Pulse output for total flow (counter reading), galvanically isolated or M-Bus (optionally)

Measuring device removable:

Dismounting of the whole measuring section is not necessary, no bypass required

Display turnable by 180°C
e.g. in case of reverse flow direction

Display shows 2 values at the same time:

- Actual flow in m³/h, l/min,...
- Total consumption (counter reading) in m³, l
- resp. temperature measurement

Values indicated in the display turnable by 180°C, e.g. in case of overhead installation

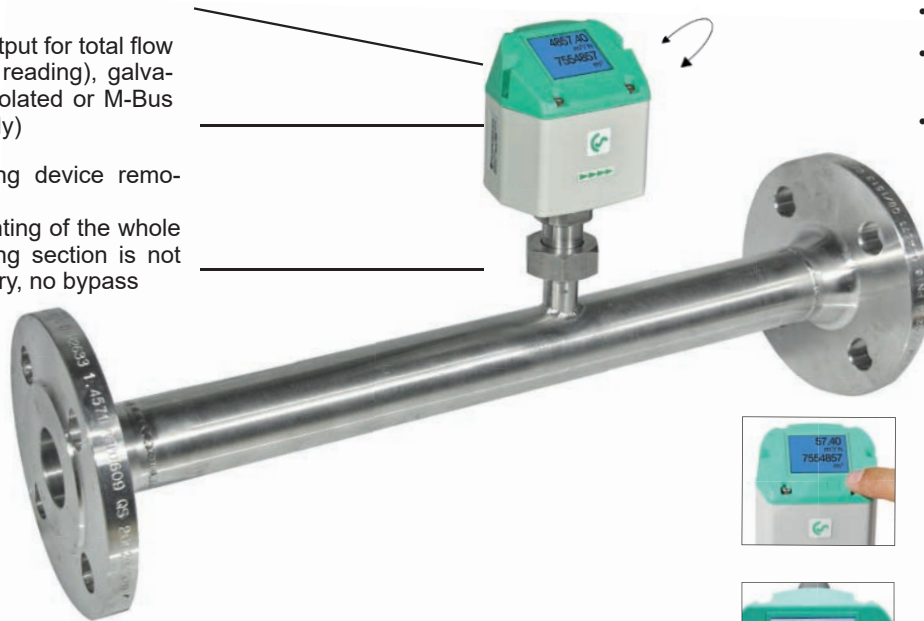

Easy installation into the existing pipeline due to integrated measuring section and weld neck flange (according to EN 1092-1 PN 40)

High measuring accuracy due to defined measuring section (inlet and outlet section)

With a key stroke:

- Reset of counter reading
- Selection of units
- Zero-point adjustment, leak flow volume suppression

Option:

Bi-directional measurement. Blue or green arrows in the display indicate the direction of flow.

A meter reading is available for each flow direction.



Application-technological features of the flow meters VA 520:

- Digital interfaces such as Modbus RTU, Ethernet (PoE) and M-Bus enable connection to higher-level systems such as energy management systems, building management systems, SPS,...
- Easy and affordable installation
- Units freely selectable via keys at the display m³/h, m³/min, l/min, l/s, kg/h, kg/min, kg/s, cfm
- Compressed air counter up to 1.999.999.999 m³. Resettable to „zero“ via keypad
- Analogue output 4...20 mA, pulse output (galvanically separated)
- High measuring accuracy also in the lower measuring range (ideal for leakage measurement)
- Negligibly small loss of pressure
- Calorimetric measuring principle, no additional pressure and temperature measurement necessary, no mechanically moved parts
- Comprehensive diagnosis functions can be read out at the display or by remote access via Modbus-RTU like e. g. exceeding Max./Min values °C, calibration cycle, error codes, serial number. All parameters can be read out and changed via Modbus

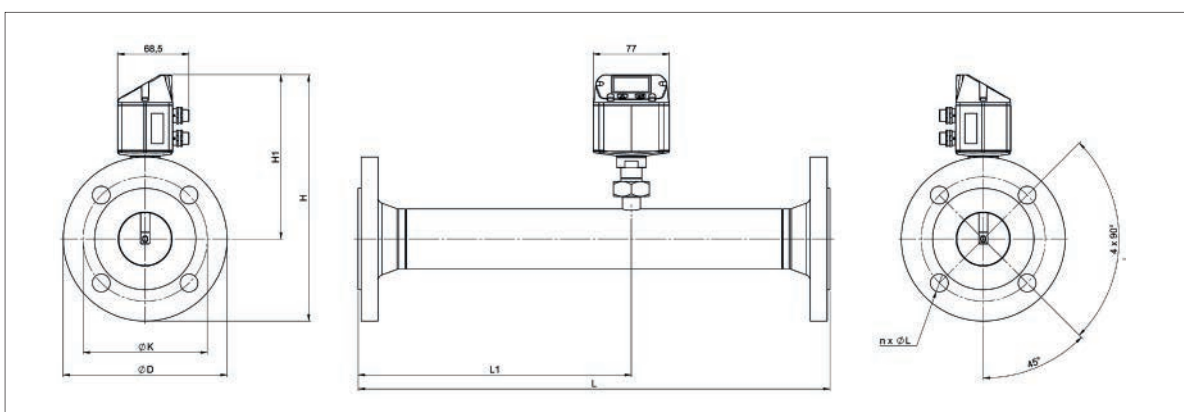

Measuring ranges flow VA 520 (Max version 185 m/s) for compressed air (ISO 1217: 1000 mbar, 20°C) Measuring ranges for other types of gas see pages 94 to 97									Flange DIN EN 1092-1		
Measuring section	Outer pipe dia. mm	Inner pipe dia. mm	Measuring range m³/h (cfm)		L mm	L1 mm	H mm	H1 mm	ØD mm	ØK mm	n x ØL
DN 15	21,3	16,1	90	50	300	210	213,2	165,7	95	65	4 x 14
DN 20	26,9	21,7	170	100	475	275	218,2	165,7	105	75	4 x 14
DN 25	33,7	27,3	290	170	475	275	223,2	165,7	115	85	4 x 14
DN 32	42,4	36,0	530	310	475	275	235,7	165,7	140	100	4 x 18
DN 40	48,3	41,9	730	430	475*	275	240,7	165,7	150	110	4 x 18
DN 50	60,3	53,1	1195	700	475*	275	248,2	165,7	165	125	4 x 18
DN 65	76,1	68,9	2050	1205	475*	275	268,2	175,7	185	145	8 x 18
DN 80	88,9	80,9	2840	1670	475*	275	275,7	175,7	200	160	8 x 18

*Attention: Shortened inlet section! Please observe the recommended minimum inlet section (length = 15 x inner diameter) on site

DESCRIPTION	ORDER-NO.
VA 520 Flow meter with integr. DN 15 measuring section with Flange	0695 2521
VA 520 Flow meter with integr. DN 20 measuring section with Flange	0695 2522
VA 520 Flow meter with integr. DN 25 measuring section with Flange	0695 2523
VA 520 Flow meter with integr. DN 32 measuring section with Flange	0695 2526
VA 520 Flow meter with integr. DN 40 measuring section with Flange	0695 2524
VA 520 Flow meter with integr. DN 50 measuring section with Flange	0695 2525
VA 520 Flow meter with integr. DN 65 measuring section with Flange	0695 2527
VA 520 Flow meter with integr. DN 80 measuring section with Flange	0695 2528
Bi-directional measurement - includes 2 x 4 ... 20 mA analog outputs and 2x pulse outputs. These are not available for Ethernet (PoE) and M-Bus interface	Z695 6000
High-pressure version PN 40	Z695 0411
ANSI flange 150 lbs (instead of DIN flanges)	Z695 5013
ANSI flange 300 lbs (instead of DIN flanges)	Z695 5014
Measuring ranges:	
Low Speed (50 m/s)	Z695 0520
Standard (92,7 m/s)	Z695 0521
High Speed (224 m/s)	Z695 0522
Options:	
Special measuring range for VA 520 according to customer requirements	Z695 4006
1 % Accuracy of m.v. ± 0,3 % of f.s.	Z695 5005
Ethernet-Interface for VA500/520 and FA500	Z695 5006
Ethernet-Interface PoE for VA500/520 and FA500	Z695 5007
M-Bus board for VA500/520 and FA500	Z695 5004
ISO calibration certificate (5 calibration points) for VA sensors	3200 0001
Gas type: ____ (specify type of gas when ordering)	Z695 5009
Gas mixture: ____ (specify gas mixture when ordering)	Z695 5010
Real gas calibration	3200 0015
Special cleaning oil and grease-free (e. g. oxygen application)	0699 4005
Silicone-free version incl. cleaning free of oil and grease	0699 4007
Additional calibration curve stored in the sensor (selectable via display)	Z695 5011
Certificate of origin	Z695 5012

TECHNICAL DATA VA 520	
Parameters:	m³/h, l/min (1000 mbar, 20 °C) at compressed air or Nm³/h, NI/min (1013 mbar, 0 °C) for gases
Units adjustable via keys at display:	m³/h, m³/min, l/min, l/s, ft³/min, cfm, m/s, kg/h, kg/min, g/s, lb/min, lb/h
Sensor:	Thermal mass flow sensor
Measuring medium:	Air, gases
Gas types are adjustable over CS service software or CS data logger:	Air, nitrogen, argon, helium, CO2, oxygen, vacuum
Measure range:	See table above
Accuracy: (m.v.: of meas. value) (f.s.: of full scale)	± 1.5 % of m.v. ± 0.3 % of f.s. on request ± 1.0 % of m.v. ± 0.3 % of f.s.
Operating temperature:	-30...80 °C
Operating pressure:	-1 to 16 bar optional to PN 40
Digital output:	RS 485 interface (Modbus-RTU), optional: Ethernet-Interface PoE), M-Bus
Analog output:	4...20 mA for m³/h e. g. l/min
Pulse output:	1 Pulse per m³ or per liter galvanically isolated. Pulse value can be set on the display. Alternatively, the pulse output can be used as an alarm relay
Supply:	18...36 VDC, 5 W
Burden:	< 500 Ω
Housing:	Polycarbonate (IP 65)
Measuring section:	stainless steel, 1.4301 or 1.4571
Process connection:	Flange (to DIN EN 1092-1 e. g. ANSI 150 lbs or ANSI 300 lbs)
Mounting position:	Any

Further accessories see pages 82 to 86

VA 520 - Inline flow meter

NEW: Modbus-RTU output
4...20 mA output for actual flow

Pulse output for total flow (counter reading), galvanically isolated or M-Bus (optionally)

Measuring device removable:
Dismounting of the whole measuring section is not necessary, no bypass required

Display can be rotated by 180°C e. g. in case of reverse flow direction

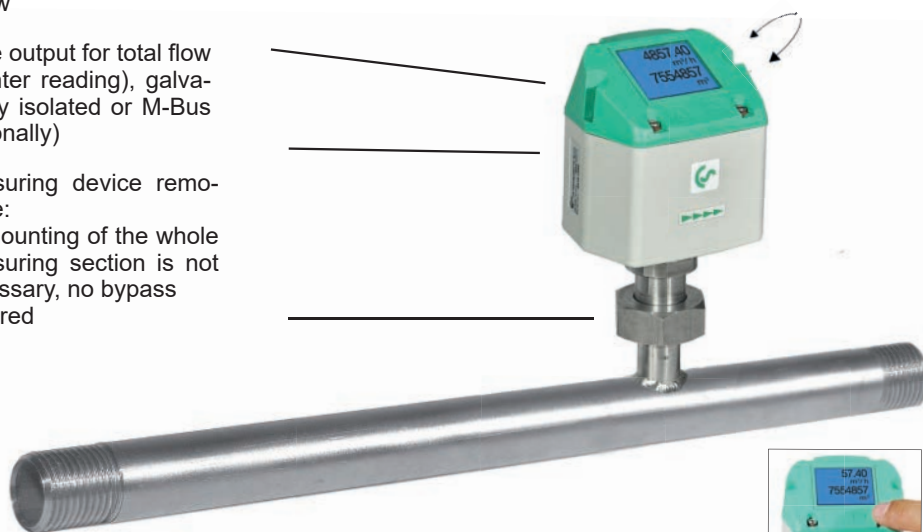

Display shows 2 values at the same time:

- Actual flow in m³/h, l/min,...
- Total consumption (counter reading) in m³, l
- resp. temperature measurement

Values indicated in the display turnable by 180°C, e.g. in case of overhead installation

With a key stroke:

- Reset of counter reading
- Selection of units
- Zero-point adjustment, leak flow volume suppression



Option:

Bi-directional measurement. Blue or green arrows in the display indicate the direction of flow.

A meter reading is available for each flow direction.

Easy installation in existing piping through integrated measuring section (1/4" to 2")

High measuring accuracy due to defined measuring section (inlet and outlet section)

Application-technological features of the flow meters VA 520:

- Digital interfaces such as Modbus RTU, Ethernet (PoE) and M-Bus enable connection to higher-level systems such as energy management systems, building management systems, SPS,...
- Easy and affordable installation
- Units freely selectable via keys at the display m³/h, m³/min, l/min, l/s, kg/h, kg/min, kg/s, cfm
- Compressed air counter up to 1.999.999.999 m³. Resettable to „zero“ via keypad
- Analogue output 4...20 mA, pulse output (galvanically separated)
- High measuring accuracy also in the lower measuring range (ideal for leakage measurement)
- Negligibly small loss of pressure
- Calorimetric measuring principle, no additional pressure and temperature measurement necessary, no mechanically moved parts
- Comprehensive diagnosis functions can be read out at the display or by remote access via Modbus-RTU like e. g. exceeding Max./Min values °C, calibration cycle, error codes, serial number. All parameters can be read out and changed via Modbus

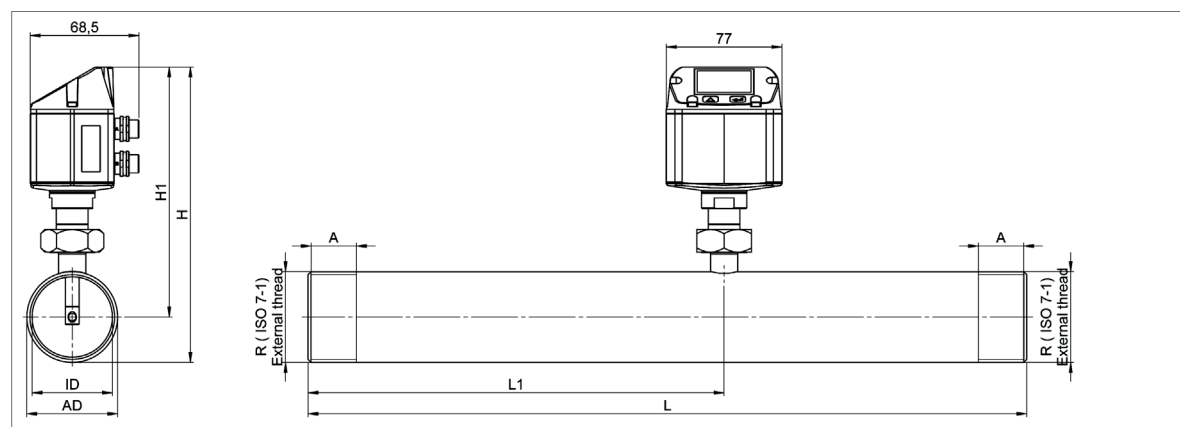

Measuring ranges flow VA 520 (Max. version 185 m/s) for compressed air (ISO 1217: 1000 mbar, 20 ° C) Measuring ranges for other types of gas see pages 94 to 97

Measuring section	Outer pipe dia. mm	Inner pipe dia. mm	Measuring ranges		L mm	L1 mm	H mm	H1 mm	A mm
			m³/h	cfm					
R 1/4"	13,7	8,9	105 l/min	3,6	194	137	174,7	165,7	15
R 1/2"	21,3	16,1	90	50	300	210	176,4	165,7	20
R 3/4"	26,9	21,7	170	100	475	275	179,2	165,7	20
R 1"	33,7	27,3	290	170	475	275	182,6	165,7	25
R 1 1/4"	42,4	36,0	530	310	475	275	186,9	165,7	25
R 1 1/2"	48,3	41,9	730	430	475*	275	186,9	165,7	25
R 2"	60,3	53,1	1195	700	475*	275	195,9	165,7	30

*Attention: Shortened inlet section! Please observe the recommended minimum inlet section (length = 15 x inner diameter) on site

DESCRIPTION	ORDER-NO. Stainless steel 1.4571	ORDER-NO. Stainless steel 1.4301	TECHNICAL DATA VA 520
VA 520 Flow meter with 1/4" measuring section	0695 1520	0695 0520	Parameters: m³/h, l/min (1000 mbar, 20 ° C) at compressed air or Nm³/h, NI/min (1013 mbar, 0 ° C) for gases Units adjustable via keys at display: m³/h, m³/min, l/min, l/s, ft/min, cfm, m/s, kg/h, kg/min, g/s, lb/min, lb/h Sensor: Thermal mass flow sensor Measuring medium: Air, gases Gas types are adjustable over CS service software or CS data logger: Air, nitrogen, argon, helium, CO2, oxygen, vacuum Measure range: See table above Accuracy: ± 1.5 % of m.v. ± 0.3 % of f.s. (m.v.: of meas. value) (f.s.: of full scale) on request ± 1.0 % of m.v. ± 0.3 % of f.s. Operating temperature: -30...80 °C Operating pressure: -1 to 16 bar optional to PN 40 Digital output: RS 485 interface (Modbus-RTU), optional: Ethernet-Interface PoE), M-Bus Analog output: 4...20 mA for m³/h e. g. l/min Pulse output: 1 Pulse per m³ or per liter galvanically isolated. Pulse value can be set on the display. Alternatively, the pulse output can be used as an alarm relay Supply: 18...36 VDC, 5 W Burden: < 500 Ω Housing: Polycarbonate (IP 65) Measuring section: Stainless steel, 1.4301 or 1.4571 Process connection: R 1/4" to R 2" (BSP British Standard Piping) or 1/2" to 2" NPT-thread Mounting position: Any
VA 520 Flow meter with 1/2" measuring section	0695 1521	0695 0521	
VA 520 Flow meter with 3/4" measuring section	0695 1522	0695 0522	
VA 520 Flow meter with 1" measuring section	0695 1523	0695 0523	
VA 520 Flow meter with 1 1/4" measuring section	0695 1526	0695 0526	
VA 520 Flow meter with 1 1/2" measuring section	0695 1524	0695 0524	
VA 520 Flow meter with 2" measuring section	0695 1525	0695 0525	
Bi-directional measurement - includes 2 x 4 ... 20 mA analog outputs and 2x pulse outputs. These are omitted for Ethernet (PoE) and M-Bus		Z695 6000	
High-pressure version PN 40		Z695 0411	
NPT thread (instead of R thread) - only available for stainless steel 1.4571		Z695 5015	
Measuring ranges:			
Low Speed (50 m/s)		Z695 0520	
Standard (92,7 m/s)		Z695 0521	
High Speed (224 m/s)		Z695 0521	
Options:			
Special measuring range for VA 520 according to customer requirements		Z695 4006	
1 % Accuracy of m.v. ± 0,3 % of f.s.		Z695 5005	
Ethernet-Interface for VA 500/520 and FA 500		Z695 5006	
Ethernet-Interface PoE for VA 500/520 and FA 500		Z695 5007	
M-Bus board for VA 500/520 and FA 500		Z695 5004	
ISO calibration certificate (5 calibration points) for VA sensors		3200 0001	
Gas type: ____ (specify type of gas when ordering)		Z695 5009	
Gas mixture: ____ (specify gas mixture when ordering)		Z695 5010	
Real gas calibration		3200 0015	
Special cleaning oil and grease-free (e. g. oxygen application)		0699 4005	
Silicone-free version incl. cleaning free of oil and grease		0699 4007	
Additional calibration curve stored in the sensor (selectable via display)		Z695 5011	
Certificate of origin		Z695 5012	

Further accessories see pages 82 to 86

VA 525 - Compact Inline flow meter

No inlet sections necessary – integrated flow straightener

The newly developed VA 525 combines modern digital interfaces for connection to an energy monitoring system with a small, compact design. The VA 525 is always used when many machines (compressed air consumers) are to be integrated into an energy monitoring network.



Display values can be rotated 180° in the display, e. g. when installing overhead

Display shows 2 values at the same time:

- Current consumption in m³/h, l/min,...
- Total consumption (meter reading) in m³, l, kg
- Temperature measurement
- **Optional:** pressure measurement

The advantages at a glance:

- Compact, small design - for use in machines, behind maintenance unit at the end user
- Optionally with classic analogue signals (4...20 mA and pulse) or digital interfaces such as Modbus RTU, Ethernet (also PoE), M-Bus
- All interfaces are programmable via the display

Screw thread:

Easy installation in existing piping through integrated measuring block (suitable for 1/4", 1/2", 3/4", 1", 1 1/4", 1 1/2" or 2" lines)

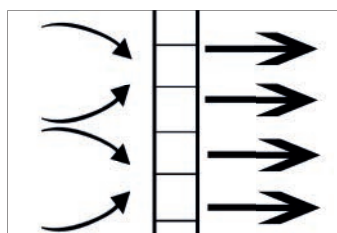

Integrated flow straightener - no inlet sections necessary



With keystroke:

- Reset counter
- Select units
- Parameterize interface

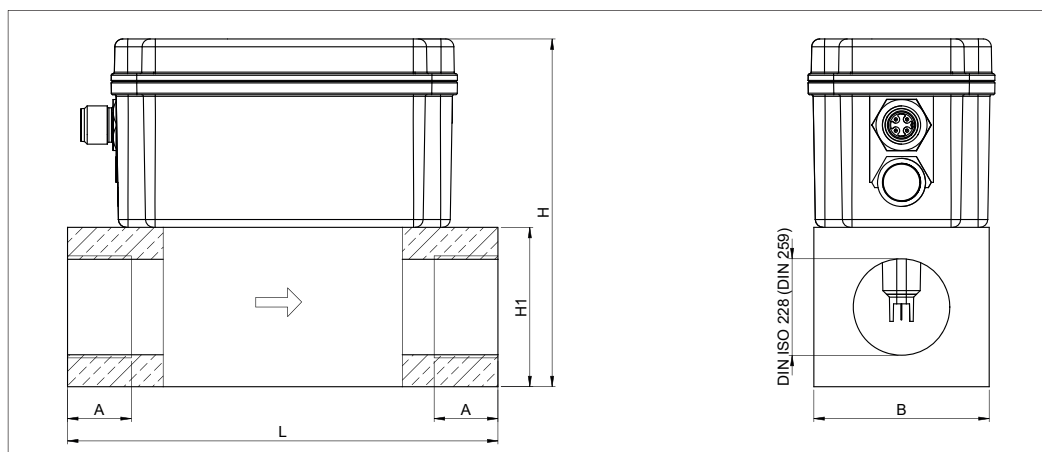

Measuring ranges flow VA 520 (Max version 185 m/s) for compressed air (ISO 1217: 1000 mbar, 20 °C). Measuring ranges for other types of gas see pages 94 to 97

Measuring section	Thread	Measuring range		L mm	B mm	H1 mm	H mm	A mm
		m ³ /h	cfm					
DN 8	G 1/4"	105 l/min	3,6	135	55	50	109,1	15
DN 15	G 1/2"	90 m ³ /h	50	135	55	50	109,1	20
DN 20	G 3/4"	170 m ³ /h	100	135	55	50	109,1	20
DN 25	G 1"	290 m ³ /h	170	135	55	50	109,1	25
DN 32	G 1 1/4"	530 m ³ /h	310	135	80	80	139,1	25
DN 40	G 1 1/2"	730 m ³ /h	430	135	80	80	139,1	25
DN 50	G 2"	1195 m ³ /h	700	135	80	80	139,1	30

Example order code VA 525:

0695 5250_A1_B1_C1_D1_E1_F1_G1_H1_I1_J1_K1_L1_M1_R1

Measuring block	
A1	1/4"
A2	1/2"
A3	3/4"
A4	1"
A5	1 1/4"
A6	1 1/2"
A7	2"

Threaded version	
B1	G female thread
B2	NPT female thread

Material	
C1	Aluminium

Calibration	
D1	No real gas adjustment - gas type setting by gas constant
D2	Real gas calibration in the gas type selected below

Typ of gas	
E1	Compressed air
E2	Nitrogen (N2)
E3	Argon (Ar)
E4	Carbon dioxide (CO2)
E5	Oxygen (O2)
E6	Nitrous oxide (N2O)
E90	Additional gas / please specify gas type (on request)
E91	Gas mixture (see page 72 - G91)

Measuring range (see table)	
F1	Low Speed version (50 m/s)
F2	Standard version (92,7 m/s)
F3	Max version (185 m/s)
F4	High Speed version (224 m/s)

Reference standard	
G1	20 °C, 1000 mbar
G2	0 °C, 1013,25 mbar
G3	15 °C, 981 mbar
G4	15 °C, 1013,25 mbar

Option display	
H1	with integrated display
H2	without display

Option pressure measurement	
I1	without pressure sensor
I2	with integrated pressure sensor 0 ... 16 bar

Option signal output/bus connection	
J1	4...20 mA analog output and pulse output
J2	Modbus-RTU (RS485)
J3	Ethernet-Interface (Modbus/TCP)
J4	Ethernet-Interface Power over Ethernet (Modbus/TCP)
J5	M-Bus

Rectifier	
K1	with integrated flow straightener, no additional inlet pipe necessary (with measuring block 1/2" to 2")
K2	without flow straightener (with measuring block 1/4")

Accuracy class	
L1	± 1,5% of m. v. ± 0,3% of f. s.
L2	± 6% of m. v. ± 0,5% of f. s.
L3	± 1% of m. v. ± 0,3% of f. s.

Maximum pressure	
M1	16 bar

Surface condition	
N1	Standard design
N2	Special cleaning oil and grease-free (e. g., for oxygen use, etc.)

Special measuring range	
R1	Special measuring range (please specify when ordering)

Order-No. VA 525

DESCRIPTION	ORDER-NR.
Compact inline flow sensor	0695 5250 + order code A...R_

TECHNICAL DATA VA 525	
Parameters:	m ³ /h, l/min (1000 mbar, 20 °C) in case of compressed air resp. Nm ³ /h, NI/min (1013 mbar, 0°C) in case of gases
Units adjustable via keys at display:	m ³ /h, m ³ /min, l/min, l/s, ft/min, cfm, m/s, kg/h, kg/min, g/s, lb/min, lb/h
Sensor:	Thermal mass flow sensor
Meas medium:	Air, gases
Gas types over CS Service Software or CS Datalogger adjustable:	Air, nitrogen, argon, CO2, oxygen
Measuring range:	See table above
Accuracy: (f. M. = from the measured value) (f. E. = from end value)	± 1,5 % of m. v. ± 0,3 % of f. s. By request: ± 1 % of m. v. ± 0,3 % of f. s. or ± 6 % of m. v. ± 0,5 % of f. s.
Pressure measurement:	0...16 bar, accuracy: 1%
Operating temp.:	-30...80 °C
Operating pressure:	Up to 16 bar
Digital output:	RS 485 interface (Modbus RTU), M-Bus (optional) Ethernet interface or PoE
Analog output:	4...20 mA for m ³ /h resp. l/min
Pulse output:	1 pulse per m ³ or per liter galvanically isolated. Pulse value adjustable on the display. Alternatively, the pulse output can be used as an alarm relay.
Power supply:	18...36 VDC, 5 W
Burden:	< 500 Ω
Housing:	Polycarbonate (IP 65)
Meas. section:	Aluminium
Mounting thread meas. section:	G 1/4" to G 2" (BSP British standard piping) resp. 1/2" to 2" NPT-thread
Mounting position:	Any



Accessories VA 500/520



DESCRIPTION	ORDER-NO.
Connection cable for VA/FA series, 5 m	0553 0104
Connection cable for VA/FA series, 10 m	0553 0105
Cable for alarm / pulse output, with M12 plug, 5 m	0553 0106
Cable for alarm / pulse output, with M12 plug, 10 m	0553 0107
Connection cable for VA / FA series, 5 m shielded	0553 0129
Connection cable for VA / FA series, 10 m shielded	0553 0130



DESCRIPTION	ORDER-NO.
Ethernet connection cable, length 5 m, M12 connector x-coded (8 pol.) on RJ 45 plug	0553 2503
Ethernet connection cable, length 10 m, M12 connector x-coded (8 pol.) on RJ 45 plug	0553 2504



DESCRIPTION	ORDER-NO.
M12 T-connector for VA 500/520 for connecting several sensors to an M-Bus or Modbus network	0 2000 0823



DESCRIPTION	ORDER-NO.
M12 plug for VA 500/520/525	0 2000 0082
M12 plug angled 90°	0219 0060

Accessories VA 500/550



DESCRIPTION	ORDER-NO.
Drilling jig incl. drill (Ø 13 mm)	0530 1108



DESCRIPTION	BESTELL-NR.
High pressure protection recommended for installations from 10 to 50 bar (VA 500)	0530 1105

- Only suitable for VA 500 with sensor length: 160 mm, 220 mm, 300 mm. For further sensor length on request



DESCRIPTION	ORDER-NO.
High pressure protection recommended for installations from 10 to 100 bar (VA 550)	0530 1115
High pressure protection recommended for installations from 10 to 16 bar DVGW (VA 550)	0530 1116



DESCRIPTION	ORDER-NO.
Thickness meter CS 0495 incl. case and calibration block	0560 0495



DESCRIPTION	ORDER-NO.
Welding Nipple, L = 35 mm, male thread, R 1/2" stainless steel 1.4301	3300 0006
Welding Nipple, L = 35 mm, male thread, R 1/2" stainless steel 1.4571	3300 0007



DESCRIPTION	ORDER-NO.
Ball valve I / I G 1/2" stainless steel	3300 0002



Accessories VA 500/550

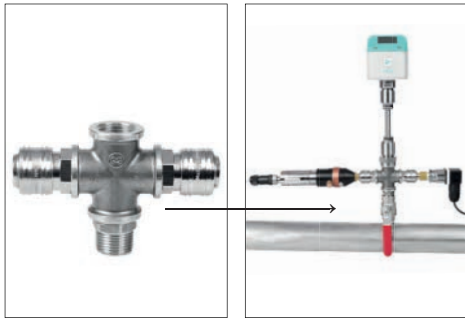

DESCRIPTION	ORDER-NO.
X-connection for connection of pressure and dew point sensor at the same measuring point (incl. 2x quick-release coupling and ball valve)	0553 0133



DESCRIPTION	ORDER-NO.
Thread adapter G 1/2" female thread to NPT 1/2" male thread	0553 0134

Accessories VA 550/570

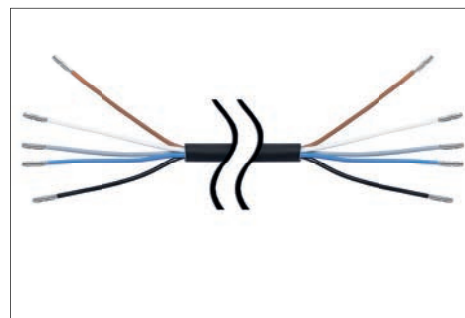

DESCRIPTION	ORDER-NO.
Connection cable 5 m with open ends	0553 0108
Connection cable 10 m with open ends	0553 0109



DESCRIPTION	ORDER-NO.
PNG cable gland - for standard	0553 0552
PNG cable gland - for ATEX	0553 0551

Accessories VA 520/570



DESCRIPTION	ORDER-NO.
Cap for measuring section VA 520 / VA 570 (Material: aluminum)	0190 0001
Cap for measuring section VA 520 / VA 570 (Material: stainless steel 1.4571)	0190 0002

Accessories for all VA 5xx



DESCRIPTION	ORDER-NO.
Power supply in wall housing for max. 2 sensors of the VA / FA 5xx series 100-240 V, 23 VA, 50-60 Hz / 24 VDC, 0.35 A	0554 0110
Power supply in wall housing for max. 4 sensors of the VA500/520 series 100-240 V, 23 VA, 50-60 Hz / 24 VDC, 0.35 A	0554 0111



DESCRIPTION	ORDER-NO.
Plug-in power supply 100-240 V, AC / 24 V for VA / FA 5xx	0554 0109

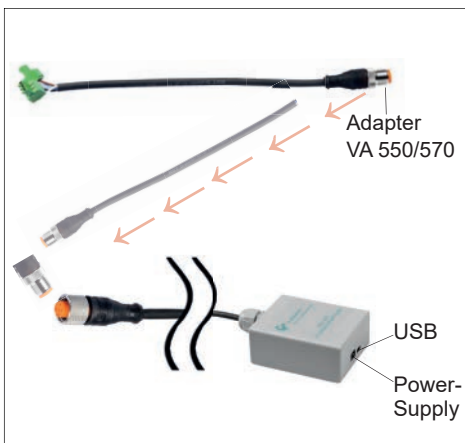

DESCRIPTION	ORDER-NO.
CS service software incl. PC connection set, USB port and interface adapter to the sensor	0554 2007



DESCRIPTION	ORDER-NO.
External gateway PROFIBUS for connection to integrated RS 485 interface	Z500 3008
External gateway PROFINET for connection to integrated RS 485 interface	Z500 3009



DESCRIPTION	ORDER-NO.
Transport case for all sensors (dimensions: 500 x 360 x 120 mm)	0554 6006

Practical accessories measuring sections



Measuring section 1/2"

EXTERNAL THREAD	PIPE (OUTSIDE Ø THICKNESS)	TOTAL LENGTH	ORDER-NO.
R 1/2"	21,3 x 2,6 mm	500 mm	4000 0015
R 3/4"	26,9 x 2,6 mm	600 mm	4000 0020
R 1"	33,7 x 3,2 mm	750 mm	4000 0025
R 1 1/4"	42,4 x 3,2 mm	900 mm	4000 0032
R 1 1/2"	48,3 x 3,2 mm	1000 mm	4000 0040
R 2"	60,3 x 3,6 mm	1250 mm	4000 0050
R 2 1/2"	76,1 x 3,6 mm	1500 mm	4000 0065
From DN 80 with flange DIN 2633			
DN 80/88,9	88,9 x 2,0 mm	1850 mm	4000 0080
DN 100/114,3	114,3 x 2,0 mm	2104 mm	4000 0100
DN 125/139,7	139,7 x 3,0 mm	2860 mm	4000 0125
DN 150/168,3	168,3 x 3,0 mm	3110 mm	4000 0150

Measuring sections for precise measurements:

Measuring section in stainless steel 1.4301 incl. ball valve, up to DN 65 (R 2 1/2") with R male thread, from DN 80 with welding neck to DIN 2633.

Useful accessories-spot drilling collars for compressed air lines



If there is no measuring site with 1/2" ball valve present it can be set up by means of spot drilling collars

The spot drilling collar is imposed onto the pipe and tightened via thread rods. The enveloping rubber gasket is pressure-tight up to 10 bar. By means of the drilling jig it is possible to drill through the 1/2" ball valve into the existing pipe.

Important: Please indicate the exact outer diameter of the existing pipe when placing the order resp. please select the suitable spot drilling collar from the adjoining list.

DESCRIPTION	DN	ORDER-NO.
Spot drilling collar for pipe-Ø 032 - 036 mm, length: 100 mm*		0500 0446
Spot drilling collar for pipe-Ø 036 - 040 mm, length: 100 mm*		0500 0448
Spot drilling collar for pipe-Ø 040 - 044 mm, length: 150 mm*		0500 0449
Spot drilling collar for pipe-Ø 044 - 051 mm, length: 200 mm*		0500 0610
Spot drilling collar for pipe-Ø 048 - 055 mm, length: 200 mm*	40	0500 0611
Spot drilling collar for pipe-Ø 052 - 059 mm, length: 200 mm*		0500 0612
Spot drilling collar for pipe-Ø 057 - 064 mm, length: 200 mm*	50	0500 0613
Spot drilling collar for pipe-Ø 063 - 070 mm, length: 200 mm*		0500 0614
Spot drilling collar for pipe-Ø 070 - 077 mm, length: 200 mm*	65	0500 0615
Spot drilling collar for pipe-Ø 075 - 083 mm, length: 200 mm*		0500 0616
Spot drilling collar for pipe-Ø 082 - 090 mm, length: 200 mm*		0500 0617
Spot drilling collar for pipe-Ø 087 - 097 mm, length: 200 mm*	80	0500 0618
Spot drilling collar for pipe-Ø 095 - 104 mm, length: 200 mm*		0500 0619
Spot drilling collar for pipe-Ø 102 - 112 mm, length: 200 mm*		0500 0620
Spot drilling collar for pipe-Ø 108 - 118 mm, length: 200 mm*	100	0500 0621
Spot drilling collar for pipe-Ø 118 - 128 mm, length: 200 mm*		0500 0622
Spot drilling collar for pipe-Ø 125 - 135 mm, length: 200 mm*		0500 0623
Spot drilling collar for pipe-Ø 133 - 144 mm, length: 200 mm*	125	0500 0624
Spot drilling collar for pipe-Ø 145 - 155 mm, length: 250 mm*		0500 0625
Spot drilling collar for pipe-Ø 151 - 161 mm, length: 250 mm*	150	0500 0626
Spot drilling collar for pipe-Ø 159 - 170 mm, length: 250 mm*		0500 0627
Spot drilling collar for pipe-Ø 168 - 180 mm, length: 250 mm*		0500 0628
Spot drilling collar for pipe-Ø 180 - 191 mm, length: 250 mm*	175	0500 0629
Spot drilling collar for pipe-Ø 193 - 203 mm, length: 300 mm*		0500 0630
Spot drilling collar for pipe-Ø 200 - 210 mm, length: 300 mm*		0500 0631
Spot drilling collar for pipe-Ø 209 - 220 mm, length: 300 mm*	200	0500 0632

*Incl. 1/2" ball valve

* not suitable for copper and plastic pipes

VA 409 - Flow direction switch for compressed air systems

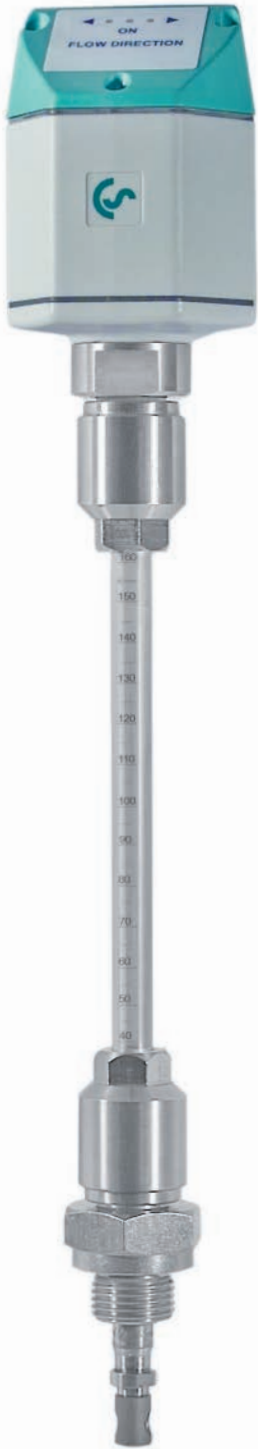

The thermal flow direction switch VA 409 with direction indication serves for determination of the flow direction of compressed air and gases especially in closed circular pipelines.

By means of VA 409 with flow direction indication the flow direction of the compressed air can be determined quickly and safely. Compared with the former mechanical paddle flow switches VA 409 is able to detect even the smallest changes in the flow direction quickly and without any mechanical movement.

The direction information in form of a potential-free contact (normally closed max. 60 VDC, 0.5 A) is transferred to the flow sensors VA 5xx or to a separate building management system (mbs). Two LEDs show the flow direction.

In connection with 2 flow sensors VA 5xx incoming and out flowing compressed air in closed circular pipelines can be measured precisely.

Special features:

- detects smallest changes < 0,1 m/s referred to 20°C and 1.000 mbar
- no mechanical wear parts
- easy installation under pressure



TECHNICAL DATA VA 409	
Detection range recognition flow direction:	< 0.1 m/s referred to auf 20 °C and 1000 mbar
Measuring principle:	calorimetric measurement
Sensor:	Pt 30/ Pt 700/ Pt 330
Measuring medium:	Air, gases
Operating temp.	0...50 °C probe tube -20...70 °C housing
Operating pressure:	up to 16 bar
Power supply:	24 VDC, 40 mA
Power input:	Max. 80 mA to 24 VDC
Protection class:	IP 54
EMV:	acc. to DIN EN 61326
Connection:	2 x M12, 5-pole, plug A and plug B
2 potential-free contacts:	2 x U max. 60 VDC, I max 0,5 A (normally closed); on request: Normally open
Housing:	Polycarbonate
Probe tube:	stainless steel, 1,4301, length 160 mm, Ø 10 mm, safety ring Ø 11.5 mm, longer probes on request
Mounting thread:	G 1/2"
Diameter housing:	65 mm
Flow direction:	2 LEDs

DESCRIPTION	ORDER-NO.
Flow direction switch VA 409	0695 0409
Mains unit in wall housing for maximum 2 sensors of the series VA/FA 5xx, 100-240 V, 23 VA, 50-60 Hz / 24 VDC, 0.35 A	0554 0110
Connection cable for VA/FA series, 5 m	0553 0104
Connection cable for VA/FA series, 10 m	0553 0105

CS Service Software - for VA 5xx meters

... including PC connection set, USB adapter and interface adapter to the meter



The flow sensors VA 5xx can be connected to the PC and the following adjustments can be carried out by means of the CS Service Software:

- Selection of the gas type (Compressed air, CO₂, N₂O, N₂, O₂, NG, Ar, CH₄)
- Selection of the units for flow, velocity, temperature, consumption
- Selection of units: m³/h, Nm³/h, m³/min, Nm³/min, ltr/h, Nltr/h, ltr/min, Nltr/min, ltr/s, Nltr/s, cfm, SCFM, kg/h, kg/min, kg/s
- Adjustment of the reference temperature, reference pressure
- Zero-point adjustment, low flow cut-off adjustable
- Modbus and M-Bus settings
- Scaling of the 4...20 mA analog output
- Reading out of: Version number, production date, serial number, date of last calibration
- Adjustment of alarm limits
- Single-point calibration (adjustment) – for this purpose a reference measuring instrument is required
- Offset settings (flow offset, temperature offset)
- Reset to factory defaults
- Transfer of updates to the sensor (firmware update, language update)

DESCRIPTION	ORDER-NO.
CS Service Software for FA/VA sensors incl. PC connection set, USB connection and interface adapter to the sensor	0554 2007

Calibration of flow meters

In the CS calibration laboratory for flow meters it is possible to calibrate our flow measuring instruments as well as of other manufacturers
High precision reference measuring instruments grant an accuracy of up 0.5 % of the measured value.



Special features:

- Due to the digital data transmission only the consumption sensor has to be calibrated. The display devices remain wired on site.

Calibration range:	from 0 to 4.000 m ³ /h under pressure
Accuracy of the reference:	between 0,5 and 1 % to measured value

DESCRIPTION	ORDER-NO.
Recalibration and 5 point precision calibration of volume flow sensors VA 500/550 with ISO certificate	0695 3333
Recalibration and 5 point precision calibration of volume flow sensors VA 520/570 with ISO certificate	0695 3332
Volume flow, freely selectable measuring points	on request
Real gas calibration	3200 0015

Measuring ranges VA 500 and VA 550

Measuring ranges Low-Speed version

Flow measuring ranges VA 500 / VA 550 - insertion meter													
Inner pipe diameter			Low-Speed version (50 m/s)										Re- com- men- ded probe length
			Measuring range Nm ³ /h * / [cfm]										
Inch	mm	DN	Air**	Nitrogen (N ₂)	Argon (Ar)	Oxygen (O ₂)	Carbon dioxide (CO ₂)	Methane Natural gas (CH ₄)	Helium (He)	Hydrogen (H ₂)	Propane (C ₃ H ₈)		
1/2"	16,1	DN 15	24 [14]	22 [13]	38 [22]	23 [13]	24 [14]	14 [8]	10 [6]	7 [4]	11 [6]		
3/4"	21,7	DN 20	48 [28]	44 [26]	75 [44]	45 [26]	47 [27]	28 [16]	20 [11]	14 [8]	22 [13]		
1"	27,3	DN 25	79 [46]	73 [43]	124 [73]	75 [44]	78 [46]	47 [27]	33 [19]	23 [13]	36 [21]		
1 1/4"	36,0	DN 32	143 [84]	132 [77]	224 [132]	136 [80]	142 [83]	85 [50]	60 [35]	42 [24]	66 [38]		
1 1/2"	41,9	DN 40	197 [116]	181 [107]	309 [182]	188 [111]	195 [115]	117 [68]	82 [48]	58 [34]	90 [53]		
2"	53,1	DN 50	323 [190]	297 [175]	506 [297]	308 [181]	320 [188]	191 [112]	135 [79]	95 [55]	148 [87]		
2 1/2"	68,9	DN 65	554 [326]	509 [300]	866 [510]	528 [311]	548 [322]	328 [193]	231 [136]	162 [95]	254 [150]		
3"	80,9	DN 80	768 [452]	706 [415]	1201 [706]	732 [431]	760 [447]	454 [267]	321 [188]	225 [132]	353 [207]		
4"	110,0	DN 100	1426 [839]	1311 [772]	2230 [1312]	1360 [800]	1411 [830]	844 [496]	596 [350]	418 [246]	655 [386]		
5"	133,7	DN 125	2110 [1241]	1940 [1141]	3299 [1941]	2011 [1183]	2088 [1228]	1248 [734]	881 [519]	619 [364]	970 [570]		
6"	159,3	DN 150	2999 [1765]	2758 [1623]	4689 [2759]	2859 [1682]	2967 [1746]	1774 [1044]	1253 [737]	880 [518]	1379 [811]		
8"	200,0	DN 200	4738 [2788]	4357 [2564]	7409 [4360]	4517 [2658]	4689 [2759]	2804 [1650]	1980 [1165]	1391 [819]	2178 [1282]		
10"	250,0	DN 250	7413 [4362]	6817 [4011]	11590 [6820]	7067 [4159]	7336 [4317]	4386 [2581]	3098 [1823]	2177 [1281]	3408 [2005]		
12"	300,0	DN 300	10687 [6289]	9828 [5783]	16710 [9833]	10189 [5996]	10576 [6224]	6324 [3721]	4466 [2628]	3138 [1847]	4914 [2891]		

Flow measuring ranges VA 500 / VA 550 - insertion meter													
Inner pipe diameter			Low-Speed version (50 m/s)										Re- com- men- ded probe length
			Measuring range Nm ³ /h * / [cfm]										
Inch	mm	DN	Corgon ®18	Corgon ®10	Corgon ®20	Forming gas 90% N ₂ + 10% H ₂	Natural gas L (CH ₄)	Biogas 50%CH ₄ + 50% CO ₂	Biogas 60% CH ₄ + 40% CO ₂	LPG 60% C ₃ H ₈ + 40% C ₄ H ₁₀	LPG 50% C ₃ H ₈ + 50% C ₄ H ₁₀	Nitrous (N ₂ O)	Ethyne/ Acetylene (C ₂ H ₂)
1/2"	16,1	DN 15	35 [21]	36 [21]	35 [20]	20 [12]	15 [9]	17 [10]	17 [10]	13 [7]	12 [7]	24 [14]	13 [8]
3/4"	21,7	DN 20	70 [41]	71 [42]	69 [40]	40 [23]	30 [17]	34 [20]	34 [20]	25 [15]	25 [14]	47 [27]	26 [15]
1"	27,3	DN 25	116 [68]	119 [70]	115 [67]	67 [39]	50 [29]	57 [34]	56 [33]	42 [24]	41 [24]	78 [45]	44 [26]
1 1/4"	36,0	DN 32	209 [123]	214 [126]	208 [122]	121 [71]	91 [53]	104 [61]	101 [59]	76 [45]	74 [44]	140 [89]	80 [47]
1 1/2"	41,9	DN 40	288 [170]	296 [174]	286 [168]	167 [98]	125 [73]	143 [84]	140 [82]	105 [62]	103 [60]	194 [114]	110 [65]
2"	53,1	DN 50	472 [278]	484 [284]	468 [275]	273 [161]	205 [120]	235 [138]	229 [135]	172 [101]	168 [99]	317 [186]	181 [106]
2 1/2"	68,9	DN 65	809 [476]	829 [488]	803 [472]	469 [276]	351 [207]	403 [237]	393 [231]	295 [173]	288 [169]	543 [320]	311 [183]
3"	80,9	DN 80	1121 [660]	1149 [676]	1112 [654]	649 [382]	487 [286]	558 [328]	544 [320]	409 [240]	400 [235]	753 [443]	430 [253]
4"	110,0	DN 100	2082 [1225]	2134 [1255]	2066 [1216]	1206 [710]	905 [532]	1037 [610]	1011 [595]	759 [447]	742 [437]	1399 [823]	800 [470]
5"	133,7	DN 125	3080 [1813]	3156 [1857]	3056 [1798]	1785 [1050]	1338 [787]	1534 [903]	1496 [880]	1123 [661]	1098 [646]	2069 [1217]	1183 [696]
6"	159,3	DN 150	4378 [2576]	4486 [2640]	4344 [2556]	2537 [1493]	1903 [1119]	2181 [1283]	2126 [1251]	1597 [939]	1561 [919]	2941 [1731]	1682 [990]
8"	200,0	DN 200	6918 [4071]	7089 [4171]	6864 [4039]	4009 [2359]	3006 [1769]	3446 [2028]	3359 [1977]	2523 [1485]	2467 [1452]	4647 [2735]	2658 [1564]
10"	250,0	DN 250	10823 [6369]	11090 [6526]	10738 [6319]	6271 [3690]	4703 [2768]	5392 [3173]	5255 [3093]	3947 [2323]	3860 [2271]	7270 [4278]	4158 [2447]
12"	300,0	DN 300	15604 [9183]	15988 [9409]	15481 [9110]	9042 [5321]	6781 [3990]	7774 [4575]	7577 [4459]	5691 [3349]	5565 [3275]	10482 [6168]	5995 [3528]

* Nm³/h according to DIN 1343: 0 °C, 1013,25 hPa for gases

** ISO 1217: 20 °C, 1000 hPa in air

If you want to measure the consumption / flow rate of a specific gas mixture, ask us.
We can offer a real gas adjustment under process conditions on request.

Measuring ranges Standard version

Flow measuring ranges VA 500 / VA 550 - insertion meter													Recom- men- ded probe length
Inner pipe diameter			Standard version (92,7 m/s)									Measuring range Nm ³ /h * / [cfm]	
			Air**	Nitrogen (N ₂)	Argon (Ar)	Oxygen (O ₂)	Carbon dioxide (CO ₂)	Methane Natural gas (CH ₄)	Helium (He)	Hydrogen (H ₂)	Propane (C ₃ H ₈)		
Inch	mm	DN											
1/2"	16,1	DN 15	45 [26]	41 [24]	71 [41]	43 [25]	45 [26]	26 [15]	19 [11]	13 [7]	20 [12]	160 mm - 6,299 inch	
3/4"	21,7	DN 20	89 [52]	81 [48]	139 [81]	84 [49]	88 [51]	52 [31]	37 [21]	26 [15]	40 [24]		
1"	27,3	DN 25	147 [86]	135 [79]	230 [135]	140 [82]	146 [86]	87 [51]	61 [36]	43 [25]	67 [39]		
1 1/4"	36,0	DN 32	266 [156]	244 [144]	416 [245]	253 [149]	263 [155]	157 [92]	111 [65]	78 [46]	122 [72]		
1 1/2"	41,9	DN 40	366 [215]	337 [198]	573 [337]	349 [205]	363 [213]	217 [127]	153 [90]	107 [63]	168 [99]		
2"	53,1	DN 50	600 [353]	551 [324]	938 [552]	572 [336]	593 [349]	355 [208]	250 [147]	176 [103]	275 [162]		
2 1/2"	68,9	DN 65	1028 [604]	945 [556]	1607 [945]	980 [576]	1017 [598]	608 [358]	429 [252]	301 [177]	472 [278]	220 mm - 8,661 inch	
3"	80,9	DN 80	1424 [838]	1309 [770]	2227 [1310]	1358 [799]	1409 [829]	842 [496]	595 [350]	418 [246]	654 [385]		
4"	110,0	DN 100	2644 [1556]	2432 [1431]	4135 [2433]	2521 [1484]	2617 [1540]	1565 [921]	1105 [650]	776 [457]	1216 [715]		
5"	133,7	DN 125	3912 [2302]	3597 [2117]	6116 [3599]	3729 [2195]	3871 [2278]	2315 [1362]	1635 [962]	1149 [676]	1798 [1058]		
6"	159,3	DN 150	5560 [3272]	5113 [3009]	8693 [5116]	5301 [3119]	5502 [3238]	3290 [1936]	2324 [1367]	1633 [961]	2556 [1504]		
8"	200,0	DN 200	8785 [5170]	8079 [4754]	13736 [8083]	8376 [4929]	8694 [5116]	5198 [3059]	3672 [2160]	2580 [1518]	4039 [2377]		
10"	250,0	DN 250	13744 [8088]	12638 [7437]	21488 [12646]	13103 [7711]	13601 [8004]	8133 [4786]	5744 [3380]	4036 [2375]	6319 [3718]	300 mm - 11,811 inch	
12"	300,0	DN 300	19814 [11661]	18221 [10723]	30980 [18232]	18891 [11117]	19609 [11539]	11725 [6900]	8281 [4873]	5819 [3424]	9110 [5361]		

Flow measuring ranges VA 500 / VA 550 - insertion meter														Recom- men- ded probe length
Inner pipe dia- meter			Standard version (92,7 m/s)											
			Measuring range Nm ³ /h * / [cfm]											
Inch	mm	DN	Corgon ®18	Corgon ®10	Corgon ®20	Forming gas 90% N ₂ + 10% H ₂	Natural gas L (CH ₄)	Biogas 50% CH ₄ + 50% CO ₂	Biogas 60% CH ₄ + 40% CO ₂	LPG 60% C ₃ H ₈ + 40% C ₄ H ₁₀	LPG 50% C ₃ H ₈ + 50% C ₄ H ₁₀	Nitrous (N ₂ O)	Ethyne/ Acetylene (C ₂ H ₂)	
1/2"	16,1	DN 15	66 [39]	68 [40]	66 [38]	38 [22]	28 [17]	33 [19]	32 [19]	24 [14]	23 [13]	44 [26]	25 [15]	160 mm - 6,299 inch
3/4"	21,7	DN 20	130 [76]	133 [78]	129 [75]	75 [44]	56 [33]	64 [38]	63 [37]	47 [27]	46 [27]	87 [51]	49 [29]	
1"	27,3	DN 25	215 [126]	220 [130]	213 [125]	124 [73]	93 [55]	107 [63]	104 [61]	78 [46]	76 [45]	144 [85]	82 [48]	
1 1/4"	36,0	DN 32	388 [228]	398 [234]	385 [227]	225 [132]	168 [99]	193 [114]	188 [111]	141 [83]	138 [81]	261 [153]	149 [87]	
1 1/2"	41,9	DN 40	535 [315]	548 [322]	531 [312]	310 [182]	232 [136]	266 [157]	260 [153]	195 [114]	191 [112]	359 [211]	205 [121]	
2"	53,1	DN 50	876 [515]	897 [528]	869 [511]	507 [298]	380 [224]	436 [256]	425 [250]	319 [188]	312 [183]	588 [346]	336 [198]	
2 1/2"	68,9	DN 65	1500 [883]	1537 [905]	1489 [876]	869 [511]	652 [383]	747 [440]	728 [428]	547 [322]	535 [315]	1008 [593]	576 [339]	220 mm - 8,661 inch
3"	80,9	DN 80	2079 [1223]	2130 [1254]	2063 [1214]	1205 [709]	903 [531]	1036 [609]	1009 [594]	758 [446]	741 [436]	1397 [822]	799 [470]	
4"	110,0	DN 100	3861 [2272]	3956 [2328]	3831 [2254]	2237 [1316]	1678 [987]	1923 [1132]	1875 [1103]	1408 [828]	1377 [810]	2594 [1526]	1483 [873]	
5"	133,7	DN 125	5711 [3361]	5852 [3444]	5666 [3335]	3309 [1947]	2482 [1460]	2845 [1674]	2773 [1632]	2083 [1226]	2037 [1198]	3837 [2258]	2194 [1291]	
6"	159,3	DN 150	8118 [4777]	8318 [4895]	8054 [4740]	4704 [2768]	3528 [2076]	4044 [2380]	3942 [2320]	2961 [1742]	2895 [1704]	5453 [3209]	3119 [1835]	
8"	200,0	DN 200	12827 [7548]	13143 [7734]	12726 [7489]	7432 [4374]	5574 [3280]	6390 [3760]	6229 [3665]	4678 [2753]	4575 [2692]	8616 [5071]	4928 [2900]	
10"	250,0	DN 250	20066 [11809]	20560 [12100]	19908 [11716]	11627 [6842]	8720 [5132]	9997 [5883]	9744 [5734]	7319 [4307]	7157 [4212]	13480 [7932]	7709 [4537]	300 mm - 11,811 inch
12"	300,0	DN 300	28930 [17025]	29643 [17444]	28702 [16891]	16763 [9865]	12572 [7399]	14413 [8482]	14048 [8267]	10552 [6209]	10318 [6072]	19434 [11437]	11115 [6541]	

* Nm³/h according to DIN 1343: 0 °C, 1013,25 hPa for gases

** ISO 1217: 20 °C, 1000 hPa in air

If you want to measure the consumption / flow rate of a specific gas mixture, ask us.
We can offer a real gas adjustment under process conditions on request.

Measuring ranges Max version

Flow measuring ranges VA 500 / VA 550 - insertion meter													
Inner pipe diameter			Max version (185,0 m/s)										Re- com- men- ded probe length
			Measuring range Nm ³ /h * / [cfm]										
Inch	mm	DN	Air**	Nitrogen (N ₂)	Argon (Ar)	Oxygen (O ₂)	Carbon dioxide (CO ₂)	Methane Natural gas (CH ₄)	Helium (He)	Hydrogen (H ₂)	Propane (C ₃ H ₈)		
1/2"	16,1	DN 15	90 [53]	83 [49]	142 [83]	86 [51]	90 [52]	53 [31]	38 [22]	26 [15]	41 [24]	160 mm - 6,299 inch	
3/4"	21,7	DN 20	177 [104]	163 [96]	278 [163]	169 [99]	175 [103]	105 [61]	74 [43]	52 [30]	81 [48]		
1"	27,3	DN 25	294 [173]	271 [159]	460 [271]	280 [165]	291 [171]	174 [102]	123 [72]	86 [50]	135 [79]		
1 1/4"	36,0	DN 32	531 [312]	488 [287]	830 [489]	506 [298]	525 [309]	314 [185]	222 [130]	156 [91]	244 [143]		
1 1/2"	41,9	DN 40	732 [430]	673 [396]	1144 [673]	697 [410]	724 [426]	433 [254]	305 [180]	215 [126]	336 [198]		
2"	53,1	DN 50	1197 [704]	1101 [648]	1872 [1101]	1141 [671]	1185 [697]	708 [417]	500 [294]	351 [206]	550 [324]		
2 1/2"	68,9	DN 65	2051 [1207]	1886 [1110]	3207 [1887]	1955 [1151]	2030 [1194]	1214 [714]	857 [504]	602 [354]	943 [555]	220 mm - 8,661 inch	
3"	80,9	DN 80	2842 [1672]	2614 [1538]	4444 [2615]	2710 [1594]	2813 [1655]	1682 [989]	1188 [699]	834 [491]	1307 [769]		
4"	110,0	DN 100	5278 [3106]	4854 [2856]	8252 [4856]	5032 [2961]	5223 [3074]	3123 [1838]	2206 [1298]	1550 [912]	2427 [1428]		
5"	133,7	DN 125	7807 [4594]	7179 [4225]	12206 [7183]	7443 [4380]	7726 [4546]	4620 [2718]	3263 [1920]	2293 [1349]	3589 [2112]		
6"	159,3	DN 150	11096 [6530]	10204 [6005]	17349 [10210]	10579 [6226]	10981 [6462]	6566 [3864]	4637 [2729]	3259 [1917]	5102 [3002]		
8"	200,0	DN 200	17533 [10318]	16123 [9488]	27413 [16132]	16716 [9837]	17351 [10211]	10375 [6105]	7328 [4312]	5149 [3030]	8061 [4744]		
10"	250,0	DN 250	27428 [16141]	25223 [14843]	42884 [25237]	26150 [15389]	27143 [15974]	16231 [9552]	11463 [6746]	8055 [4740]	12611 [7421]	300 mm - 11,811 inch	
12"	300,0	DN 300	39544 [23271]	36364 [21400]	61827 [36385]	37701 [22187]	39133 [23030]	23400 [13771]	16527 [9726]	11614 [6834]	18182 [10700]		

Flow measuring ranges VA 500 / VA 550 - insertion meter														
Inner pipe dia- meter			Max version (185,0 m/s)											Re- com- men- ded probe length
			Measuring range Nm ³ /h * / [cfm]											
Inch	mm	DN	Corgon ®18	Corgon ®10	Corgon ®20	Forming gas 90% N ₂ + 10% H ₂	Natural gas L(CH ₄)	Biogas 50% CH ₄ + 50% CO ₂	Biogas 60% CH ₄ + 40% CO ₂	LPG 60% C ₃ H ₈ + 40% C ₄ H ₁₀	LPG 50% C ₃ H ₈ + 50% C ₄ H ₁₀	Nitrous (N ₂ O)	Ethyne/ Acetylene (C ₂ H ₂)	
1/2"	16,1	DN 15	132 [78]	136 [80]	131 [77]	76 [45]	57 [33]	66 [38]	64 [37]	48 [28]	47 [27]	89 [52]	51 [30]	160 mm - 6,299 inch
3/4"	21,7	DN 20	259 [152]	266 [156]	257 [151]	150 [88]	112 [66]	129 [76]	126 [74]	94 [55]	92 [54]	174 [102]	99 [58]	
1"	27,3	DN 25	430 [253]	440 [259]	426 [251]	249 [146]	187 [110]	214 [126]	208 [122]	156 [92]	153 [90]	289 [170]	165 [97]	
1 1/4"	36,0	DN 32	775 [456]	795 [467]	769 [453]	449 [264]	337 [198]	386 [227]	376 [221]	283 [166]	276 [162]	521 [306]	298 [175]	
1 1/2"	41,9	DN 40	1068 [629]	1095 [644]	1060 [624]	619 [364]	464 [273]	532 [313]	519 [305]	389 [229]	381 [224]	718 [422]	410 [241]	
2"	53,1	DN 50	1748 [1029]	1791 [1054]	1734 [1020]	1013 [596]	759 [447]	871 [512]	849 [499]	637 [375]	623 [367]	1174 [691]	671 [395]	
2 1/2"	68,9	DN 65	2995 [1762]	3069 [1806]	2971 [1748]	1735 [1021]	1301 [766]	1492 [878]	1454 [856]	1092 [642]	1068 [628]	2012 [1184]	1150 [677]	220 mm - 8,661 inch
3"	80,9	DN 80	4150 [2442]	4252 [2502]	4117 [2423]	2404 [1415]	1803 [1061]	2067 [1216]	2015 [1186]	1513 [890]	1480 [871]	2788 [1640]	1594 [938]	
4"	110,0	DN 100	7706 [4535]	7896 [4647]	7646 [4499]	4465 [2628]	3349 [1971]	3839 [2259]	3742 [2202]	2811 [1654]	2748 [1617]	5177 [3046]	2961 [1742]	
5"	133,7	DN 125	11399 [6708]	11679 [6873]	11309 [6655]	6605 [3887]	4954 [2915]	5679 [3342]	5535 [3257]	4157 [2446]	4065 [2392]	7657 [4506]	4379 [2577]	
6"	159,3	DN 150	16201 [9534]	16600 [9769]	16074 [9459]	9388 [5524]	7041 [4143]	8071 [4750]	7867 [4630]	5909 [3477]	5778 [3400]	10883 [6405]	6224 [3663]	
8"	200,0	DN 200	25599 [15065]	26229 [15436]	25397 [14946]	14833 [8729]	11125 [6547]	12753 [7505]	12431 [7315]	9337 [5494]	9130 [5373]	17196 [10120]	9835 [5788]	
10"	250,0	DN 250	40046 [23567]	41033 [24148]	39731 [23382]	23205 [13656]	17404 [10242]	19951 [11741]	19447 [11444]	14606 [8596]	14283 [8406]	26901 [15831]	15386 [9054]	
12"	300,0	DN 300	57736 [33977]	59158 [34814]	57281 [33710]	33455 [19688]	25091 [14766]	28764 [16927]	28037 [16499]	21058 [12393]	20593 [12119]	38784 [22824]	22182 [13054]	

* Nm³/h according to DIN 1343: 0 °C, 1013,25 hPa for gases

** ISO 1217: 20 °C, 1000 hPa in air

If you want to measure the consumption / flow rate of a specific gas mixture, ask us.
We can offer a real gas adjustment under process conditions on request.

Measuring ranges High-Speed version

Flow measuring ranges VA 500 / VA 550 - insertion meter												
Inner pipe diameter			High-Speed version (224,0 m/s)									Recom- mended probe length
			Measuring range Nm ³ /h * / [cfm]									
Inch	mm	DN	Air**	Nitrogen (N ₂)	Argon (Ar)	Oxygen (O ₂)	Carbon dioxide (CO ₂)	Methane Natural gas (CH ₄)	Helium (He)	Hydrogen (H ₂)	Propane (C ₃ H ₈)	
1/2"	16,1	DN 15	110 [64]	101 [59]	172 [101]	105 [61]	109 [64]	65 [38]	46 [27]	32 [19]	50 [29]	160 mm - 6,299 inch
3/4"	21,7	DN 20	215 [126]	198 [116]	336 [198]	205 [120]	213 [125]	127 [74]	89 [52]	63 [37]	99 [58]	
1"	27,3	DN 25	356 [210]	328 [193]	557 [328]	340 [200]	353 [207]	211 [124]	149 [87]	104 [61]	164 [96]	
1 1/4"	36,0	DN 32	643 [378]	591 [348]	1006 [592]	613 [361]	636 [374]	380 [224]	268 [158]	188 [111]	295 [174]	
1 1/2"	41,9	DN 40	886 [521]	815 [479]	1385 [815]	845 [497]	877 [516]	524 [308]	370 [218]	260 [153]	407 [239]	
2"	53,1	DN 50	1450 [853]	1333 [784]	2267 [1334]	1382 [813]	1434 [844]	858 [504]	606 [356]	425 [250]	666 [392]	220 mm - 8,661 inch
2 1/2"	68,9	DN 65	2484 [1461]	2284 [1344]	3883 [2285]	2368 [1393]	2458 [1446]	1469 [865]	1038 [611]	729 [429]	1142 [672]	
3"	80,9	DN 80	3441 [2025]	3165 [1862]	5381 [3166]	3281 [1931]	3406 [2004]	2036 [1198]	1438 [846]	1010 [594]	1582 [931]	
4"	110,0	DN 100	6391 [3761]	5877 [3458]	9992 [5880]	6093 [3586]	6324 [3722]	3782 [2225]	2671 [1572]	1877 [1104]	2938 [1729]	
5"	133,7	DN 125	9453 [5563]	8693 [5116]	14780 [8698]	9012 [5304]	9355 [5505]	5594 [3292]	3951 [2325]	2776 [1633]	4346 [2558]	
6"	159,3	DN 150	13436 [7907]	12355 [7271]	21007 [12362]	12810 [7538]	13296 [7825]	7950 [4679]	5615 [3304]	3946 [2322]	6177 [3635]	300 mm - 11,811 inch
8"	200,0	DN 200	21229 [12493]	19522 [11489]	33192 [19533]	20240 [11911]	21009 [12363]	12562 [7393]	8873 [5221]	6235 [3669]	9761 [5744]	
10"	250,0	DN 250	33211 [19544]	30540 [17973]	51925 [30557]	31663 [18633]	32865 [19341]	19652 [11565]	13880 [8168]	9753 [5740]	15270 [8986]	
12"	300,0	DN 300	47880 [28177]	44030 [25912]	74861 [44055]	45649 [26864]	47383 [27885]	28333 [16674]	20012 [11777]	14062 [8275]	22015 [12956]	

Flow measuring ranges VA 500 / VA 550 - insertion meter														
Inner pipe diameter			High-Speed version (224,0 m/s)											Recom- mended probe length
			Measuring range Nm ³ /h * / [cfm]											
Inch	mm	DN	Corgon @18	Corgon @10	Corgon @20	Forming gas 90% N ₂ + 10% H ₂	Natural gas L (CH ₄)	Biogas 50% CH ₄ + 50% CO ₂	Biogas 60% CH ₄ + 40% CO ₂	LPG 60% C ₃ H ₈ + 40% C ₄ H ₁₀	LPG 50% C ₃ H ₈ + 50% C ₄ H ₁₀	Nitrous (N ₂ O)	Ethyne/ Acetylene (C ₂ H ₂)	
1/2"	16,1	DN 15	160 [94]	164 [96]	159 [93]	93 [54]	69 [41]	80 [47]	78 [45]	58 [34]	57 [33]	108 [63]	61 [36]	160 mm - 6,299 inch
3/4"	21,7	DN 20	314 [185]	322 [189]	311 [183]	182 [107]	136 [80]	156 [92]	152 [89]	114 [67]	112 [65]	211 [124]	120 [71]	
1"	27,3	DN 25	521 [306]	533 [314]	516 [304]	301 [177]	226 [133]	259 [152]	253 [148]	190 [111]	185 [109]	349 [205]	200 [117]	
1 1/4"	36,0	DN 32	939 [552]	962 [566]	932 [548]	544 [320]	408 [240]	468 [275]	456 [268]	342 [201]	335 [197]	631 [371]	360 [212]	
1 1/2"	41,9	DN 40	1294 [761]	1326 [780]	1284 [755]	749 [441]	562 [331]	644 [379]	628 [369]	472 [277]	461 [271]	869 [511]	497 [292]	
2"	53,1	DN 50	2117 [1245]	2169 [1276]	2100 [1236]	1226 [721]	920 [541]	1054 [620]	1028 [605]	772 [454]	755 [444]	1422 [836]	813 [478]	220 mm - 8,661 inch
2 1/2"	68,9	DN 65	3626 [2134]	3716 [2186]	3598 [2117]	2101 [1236]	1576 [927]	1806 [1063]	1761 [1036]	1322 [778]	1293 [761]	2436 [1433]	1393 [820]	
3"	80,9	DN 80	5025 [2957]	5149 [3030]	4985 [2934]	2911 [1713]	2183 [1285]	2503 [1473]	2440 [1436]	1832 [1078]	1792 [1054]	3375 [1986]	1930 [1136]	
4"	110,0	DN 100	9331 [5491]	9561 [5626]	9258 [5448]	5407 [3182]	4055 [2386]	4649 [2735]	4531 [2666]	3403 [2003]	3328 [1958]	6268 [3689]	3585 [2109]	
5"	133,7	DN 125	13802 [8122]	14142 [8322]	13693 [8058]	7997 [4706]	5998 [3530]	6876 [4046]	6702 [3944]	5034 [2962]	4923 [2897]	9271 [5456]	5302 [3120]	
6"	159,3	DN 150	19617 [11544]	20100 [11829]	19462 [11453]	11367 [6689]	8525 [5017]	9773 [5751]	9526 [5606]	7155 [4210]	6997 [4117]	13178 [7755]	7537 [4435]	300 mm - 11,811 inch
8"	200,0	DN 200	30996 [18241]	31759 [18690]	30752 [18097]	17960 [10569]	13470 [7927]	15442 [9087]	15051 [8858]	11305 [6653]	11055 [6506]	20821 [12253]	11908 [7008]	
10"	250,0	DN 250	48489 [28535]	49683 [29238]	48107 [28311]	28097 [16535]	21072 [12401]	24157 [14216]	23546 [13857]	17686 [10408]	17295 [10178]	32573 [19169]	18629 [10963]	
12"	300,0	DN 300	69907 [41140]	71629 [42153]	69357 [40816]	40508 [23839]	30381 [17879]	34828 [20496]	33947 [19978]	25498 [15005]	24934 [14674]	46961 [27636]	26858 [15866]	

* Nm³/h according to DIN 1343: 0 °C, 1013,25 hPa for gases

** ISO 1217: 20 °C, 1000 hPa in air

If you want to measure the consumption / flow rate of a specific gas mixture, ask us.
We can offer a real gas adjustment under process conditions on request.

Measuring ranges VA 570 / VA 520 / VA 525

Measuring ranges Low-Speed version

Flow measuring ranges VA 570 / VA 520 / VA 525												
Inner pipe diameter			Low-Speed version (50 m/s)									
			Measuring range Nm ³ /h * / [cfm]									
Inch	mm	DN	Air**	Nitrogen (N ₂)	Argon (Ar)	Oxygen (O ₂)	Carbon dioxide (CO ₂)	Methane Natural gas (CH ₄)	Helium (He)	Hydrogen (H ₂)	Propane (C ₃ H ₈)	
1/4"	8,9	DN 8	25 NI/min [0,9]	25 NI/min [0,9]	45 NI/min [1,5]	25 NI/min [0,9]	25 NI/min [0,9]	15 NI/min [0,6]	735 NI/h [0,3]	515 NI/h [0,3]	810 NI/h [0,3]	
1/2"	16,1	DN 15	20 [14,4]	20 [13,2]	35 [20]	20 [13,5]	20 [14,1]	240 NI/min [8,4]	170 NI/min [6]	120 NI/min [4,2]	185 NI/min [6,6]	
3/4"	21,7	DN 20	45 [25]	40 [25]	75 [40]	45 [25]	45 [25]	25 [15]	20 [11,7]	235 NI/min [8,1]	20 [12,9]	
1"	27,3	DN 25	75 [45]	70 [40]	120 [70]	75 [40]	75 [45]	45 [25]	30 [15]	20 [13,5]	35 [20]	
1 1/4"	36,0	DN 32	140 [80]	130 [75]	220 [130]	135 [80]	140 [80]	85 [50]	60 [35]	40 [20]	65 [35]	
1 1/2"	41,9	DN 40	195 [115]	180 [105]	305 [180]	185 [110]	195 [115]	115 [65]	80 [45]	55 [30]	90 [50]	
2"	53,1	DN 50	320 [190]	295 [175]	505 [295]	305 [180]	320 [185]	190 [110]	135 [75]	95 [55]	145 [85]	
2 1/2"	68,9	DN 65	550 [325]	505 [300]	865 [510]	525 [310]	545 [320]	325 [190]	230 [135]	160 [95]	250 [150]	
3"	80,9	DN 80	765 [450]	705 [415]	1200 [705]	730 [430]	760 [445]	450 [265]	320 [185]	225 [130]	350 [205]	

Flow measuring ranges VA 570 / VA 520 / VA 525													
Inner pipe diameter			Low-Speed version (50 m/s)										
			Measuring range Nm ³ /h * / [cfm]										
Inch	mm	DN	Corgon ®18	Corgon 10	Corgon ®20	Forming gas 90% N ₂ + 10% H ₂	Natural gas L (CH ₄)	Biogas 50%CH ₄ + 50% CO ₂	Biogas 60% CH ₄ + 40% CO ₂	LPG 60% C ₃ H ₈ + 40% C ₄ H ₁₀	LPG 50% C ₃ H ₈ + 50% C ₄ H ₁₀	Nitrous (N ₂ O)	Ethyne/ Acetylene (C ₂ H ₂)
1/4"	8,9	DN 8	40 NI/min [1,5]	40 NI/min [1,5]	40 NI/min [1,5]	20 NI/min [0,6]	15 NI/min [0,6]	20 NI/min [0,6]	20 NI/min [0,6]	15 NI/min [0,3]	15 NI/min [0,3]	25 NI/min [0,9]	15 NI/min [0,3]
1/2"	16,1	DN 15	35 [20]	35 [20]	35 [20]	20 [12]	15 [9]	15 [10,5]	15 [10,2]	215 NI/min [7,5]	210 NI/min [7,5]	20 [14,1]	225 NI/min [8,1]
3/4"	21,7	DN 20	70 [40]	70 [40]	65 [40]	40 [20]	30 [15]	30 [20]	30 [20]	25 [15]	25 [14,7]	45 [25]	25 [15]
1"	27,3	DN 25	115 [65]	115 [70]	115 [65]	65 [35]	50 [25]	55 [30]	55 [30]	40 [20]	40 [20]	75 [45]	40 [25]
1 1/4"	36,0	DN 32	205 [120]	210 [125]	205 [120]	120 [70]	90 [50]	100 [60]	100 [55]	75 [45]	70 [40]	140 [80]	80 [45]
1 1/2"	41,9	DN 40	285 [170]	295 [170]	285 [165]	165 [95]	125 [70]	140 [80]	140 [80]	105 [60]	100 [60]	190 [110]	110 [65]
2"	53,1	DN 50	470 [275]	480 [280]	465 [275]	270 [160]	205 [120]	235 [135]	225 [135]	170 [100]	165 [95]	315 [185]	180 [105]
2 1/2"	68,9	DN 65	805 [475]	825 [485]	800 [470]	465 [275]	350 [205]	400 [235]	390 [230]	295 [170]	285 [165]	540 [320]	310 [180]
3"	80,9	DN 80	1120 [660]	1145 [675]	1110 [650]	645 [380]	485 [285]	555 [325]	540 [320]	405 [240]	400 [235]	750 [440]	430 [250]

* Nm³/h according to DIN 1343: 0 °C, 1013,25 hPa for gases

** ISO 1217: 20 °C, 1000 hPa in air

If you want to measure the consumption / flow rate of a specific gas mixture, ask us.
We can offer a real gas adjustment under process conditions on request.

Measuring ranges Standard version

Flow measuring ranges VA 570 / VA 520 / VA 525											
Inner pipe diameter			Standard version (92,7 m/s)								
			Measuring range Nm ³ /h * / [cfm]								
Inch	mm	DN	Air**	Nitrogen (N ₂)	Argon (Ar)	Oxygen (O ₂)	Carbon dioxide (CO ₂)	Methane Natural gas (CH ₄)	Helium (He)	Hydrogen (H ₂)	Propane (C ₃ H ₈)
1/4"	8,9	DN 8	50 NI/min [1,8]	50 NI/min [1,5]	85 NI/min [3]	50 NI/min [1,8]	50 NI/min [1,8]	30 NI/min [0,9]	20 NI/min [0,6]	15 NI/min [0,3]	25 NI/min [0,6]
1/2"	16,1	DN 15	45 [25]	40 [20]	70 [40]	40 [25]	45 [25]	25 [15]	15 [11,1]	220 NI/min [7,8]	20 [12,3]
3/4"	21,7	DN 20	85 [50]	80 [45]	135 [80]	80 [45]	85 [50]	50 [30]	35 [20]	25 [15]	40 [20]
1"	27,3	DN 25	145 [85]	135 [75]	230 [135]	140 [80]	145 [85]	85 [50]	60 [35]	40 [25]	65 [35]
1 1/4"	36,0	DN 32	265 [155]	240 [140]	415 [245]	250 [145]	260 [155]	155 [90]	110 [65]	75 [45]	120 [70]
1 1/2"	41,9	DN 40	365 [215]	335 [195]	570 [335]	345 [205]	360 [210]	215 [125]	150 [90]	105 [60]	165 [95]
2"	53,1	DN 50	600 [350]	550 [320]	935 [550]	570 [335]	590 [345]	355 [205]	250 [145]	175 [100]	275 [160]
2 1/2"	68,9	DN 65	1025 [600]	945 [555]	1605 [945]	980 [575]	1015 [595]	605 [355]	425 [250]	300 [175]	470 [275]
3"	80,9	DN 80	1420 [835]	1305 [770]	2225 [1310]	1355 [795]	1405 [825]	840 [495]	595 [350]	415 [245]	650 [385]

Flow measuring ranges VA 570 / VA 520 / VA 525													
Inner pipe diameter			Standard version (92,7 m/s)										
			Measuring range Nm ³ /h * / [cfm]										
Inch	mm	DN	Corgon ®18	Corgon ®10	Corgon ®20	Forming gas 90% N ₂ + 10% H ₂	Natural gas L (CH ₄)	Biogas 50% CH ₄ + 50% CO ₂	Biogas 60% CH ₄ + 40% CO ₂	LPG 60% C ₃ H ₈ + 40% C ₄ H ₁₀	LPG 50% C ₃ H ₈ + 50% C ₄ H ₁₀	Nitrous (N ₂ O)	Ethyne/ Acetylene (C ₂ H ₂)
1/4"	8,9	DN 8	75 NI/min [2,7]	80 NI/min [2,7]	75 NI/min [2,7]	45 NI/min [1,5]	30 NI/min [1,2]	35 NI/min [1,2]	35 NI/min [1,2]	25 NI/min [0,9]	25 NI/min [0,9]	50 NI/min [1,8]	30 NI/min [0,9]
1/2"	16,1	DN 15	65 [35]	65 [40]	65 [35]	35 [20]	25 [15]	30 [15]	30 [15]	20 [14,1]	20 [13,8]	40 [25]	25 [15]
3/4"	21,7	DN 20	130 [75]	130 [75]	125 [75]	75 [40]	55 [30]	60 [35]	60 [35]	45 [25]	45 [25]	85 [50]	45 [25]
1"	27,3	DN 25	215 [125]	220 [130]	210 [125]	120 [70]	90 [55]	105 [60]	100 [60]	75 [45]	75 [45]	140 [85]	80 [45]
1 1/4"	36,0	DN 32	385 [225]	395 [230]	385 [225]	225 [130]	165 [95]	190 [110]	185 [110]	140 [80]	135 [80]	260 [150]	145 [85]
1 1/2"	41,9	DN 40	535 [315]	545 [320]	530 [310]	310 [180]	230 [135]	265 [155]	260 [150]	195 [110]	190 [110]	355 [210]	205 [120]
2"	53,1	DN 50	875 [515]	895 [525]	865 [510]	505 [295]	380 [220]	435 [255]	425 [250]	315 [185]	310 [180]	585 [345]	335 [195]
2 1/2"	68,9	DN 65	1500 [880]	1535 [905]	1485 [875]	865 [510]	650 [380]	745 [440]	725 [425]	545 [320]	535 [315]	1005 [590]	575 [335]
3"	80,9	DN 80	2075 [1220]	2130 [1250]	2060 [1210]	1205 [705]	900 [530]	1035 [605]	1005 [590]	755 [445]	740 [435]	1395 [820]	795 [470]

* Nm³/h according to DIN 1343: 0 °C, 1013,25 hPa for gases

** ISO 1217: 20 °C, 1000 hPa in air

If you want to measure the consumption / flow rate of a specific gas mixture, ask us.
We can offer a real gas adjustment under process conditions on request.

Measuring ranges Max version

Flow measuring ranges VA 570 / VA 520 / VA 525												
			Max version (185,0 m/s)									
Inner pipe diameter			Measuring range Nm ³ /h * / [cfm]									
Inch	mm	DN	Air**	Nitrogen (N ₂)	Argon (Ar)	Oxygen (O ₂)	Carbon dioxide (CO ₂)	Methane Natural gas (CH ₄)	Helium (He)	Hydrogen (H ₂)	Propane (C ₃ H ₈)	
1/4"	8,9	DN 8	105 NI/min [3,6]	100 NI/min [3,3]	170 NI/min [6]	100 NI/min [3,6]	105 NI/min [3,6]	60 NI/min [2,1]	45 NI/min [1,5]	30 NI/min [0,9]	50 NI/min [1,5]	
1/2"	16,1	DN 15	90 [50]	80 [45]	140 [80]	85 [50]	90 [50]	50 [30]	35 [20]	25 [15]	40 [20]	
3/4"	21,7	DN 20	175 [100]	160 [95]	275 [160]	165 [95]	175 [100]	105 [60]	70 [40]	50 [30]	80 [45]	
1"	27,3	DN 25	290 [170]	270 [155]	460 [270]	280 [165]	290 [170]	170 [100]	120 [70]	85 [50]	135 [75]	
1 1/4"	36,0	DN 32	530 [310]	485 [285]	830 [485]	505 [295]	525 [305]	310 [185]	220 [130]	155 [90]	240 [140]	
1 1/2"	41,9	DN 40	730 [430]	670 [395]	1140 [670]	695 [410]	720 [425]	430 [250]	305 [180]	215 [125]	335 [195]	
2"	53,1	DN 50	1195 [700]	1100 [645]	1870 [1100]	1140 [670]	1185 [695]	705 [415]	500 [290]	350 [205]	550 [320]	
2 1/2"	68,9	DN 65	2050 [1205]	1885 [1110]	3205 [1885]	1955 [1150]	2030 [1190]	1210 [710]	855 [500]	600 [350]	940 [555]	
3"	80,9	DN 80	2840 [1670]	2610 [1535]	4440 [2615]	2710 [1590]	2810 [1655]	1680 [985]	1185 [695]	830 [490]	1305 [765]	

Flow measuring ranges VA 570 / VA 520 / VA 525													
			Max version (185,0 m/s)										
Inner pipe diameter			Measuring range Nm ³ /h * / [cfm]										
Inch	mm	DN	Corgon ®18	Corgon ®10	Corgon ®20	Forming gas 90% N ₂ + 10% H ₂	Natural gas L (CH ₄)	Biogas 50% CH ₄ + 50% CO ₂	Biogas 60% CH ₄ + 40% CO ₂	LPG 60% C ₃ H ₈ + 40% C ₄ H ₁₀	LPG 50% C ₃ H ₈ + 50% C ₄ H ₁₀	Nitrous (N ₂ O)	Ethyne/Acetylene (C ₂ H ₂)
1/4"	8,9	DN 8	155 NI/min [5,4]	160 NI/min [5,7]	155 NI/min [5,4]	90 NI/min [3]	65 NI/min [2,4]	75 NI/min [2,7]	75 NI/min [2,7]	55 NI/min [1,8]	55 NI/min [1,8]	105 NI/min [3,6]	60 NI/min [2,1]
1/2"	16,1	DN 15	130 [75]	135 [80]	130 [75]	75 [45]	55 [30]	65 [35]	60 [35]	45 [25]	45 [25]	85 [50]	50 [30]
3/4"	21,7	DN 20	255 [150]	265 [155]	255 [150]	150 [85]	110 [65]	125 [75]	125 [70]	90 [55]	90 [50]	170 [100]	95 [55]
1"	27,3	DN 25	430 [250]	440 [255]	425 [250]	245 [145]	185 [110]	210 [125]	205 [120]	155 [90]	150 [90]	285 [170]	165 [95]
1 1/4"	36,0	DN 32	775 [455]	795 [465]	765 [450]	445 [260]	335 [195]	385 [225]	375 [220]	280 [165]	275 [160]	520 [305]	295 [175]
1 1/2"	41,9	DN 40	1065 [625]	1095 [640]	1060 [620]	615 [360]	460 [270]	530 [310]	515 [305]	385 [225]	380 [220]	715 [420]	410 [240]
2"	53,1	DN 50	1745 [1025]	1790 [1050]	1730 [1020]	1010 [595]	755 [445]	870 [510]	845 [495]	635 [375]	620 [365]	1170 [690]	670 [395]
2 1/2"	68,9	DN 65	2995 [1760]	3065 [1805]	2970 [1745]	1735 [1020]	1300 [765]	1490 [875]	1450 [855]	1090 [640]	1065 [625]	2010 [1180]	1150 [675]
3"	80,9	DN 80	4150 [2440]	4250 [2500]	4115 [2420]	2400 [1415]	1800 [1060]	2065 [1215]	2015 [1185]	1510 [890]	1480 [870]	2785 [1640]	1590 [935]

* Nm³/h according to DIN 1343: 0 °C, 1013,25 hPa for gases

** ISO 1217: 20 °C, 1000 hPa in air

If you want to measure the consumption / flow rate of a specific gas mixture, ask us.
We can offer a real gas adjustment under process conditions on request.

Measuring ranges High-Speed version

Flow measuring ranges VA 570 / VA 520 / VA 525												
Inner pipe diameter			High-Speed version (224,0 m/s)									
			Measuring range Nm ³ /h * / [cfm]									
Inch	mm	DN	Air**	Nitrogen (N ₂)	Argon (Ar)	Oxygen (O ₂)	Carbon dioxide (CO ₂)	Methane Natural gas (CH ₄)	Helium (He)	Hydrogen (H ₂)	Propane (C ₃ H ₈)	
1/4"	8,9	DN 8	130 NI/min [4,5]	120 NI/min [4,2]	205 NI/min [7,2]	125 NI/min [4,2]	130 NI/min [4,5]	75 NI/min [2,7]	55 NI/min [1,8]	35 NI/min [1,2]	60 NI/min [2,1]	
1/2"	16,1	DN 15	110 [60]	100 [55]	170 [100]	105 [60]	105 [60]	65 [35]	45 [25]	30 [15]	50 [25]	
3/4"	21,7	DN 20	215 [125]	195 [115]	335 [195]	205 [120]	210 [125]	125 [70]	85 [50]	60 [35]	95 [55]	
1"	27,3	DN 25	355 [210]	325 [190]	555 [325]	340 [200]	350 [205]	210 [120]	145 [85]	100 [60]	160 [95]	
1 1/4"	36,0	DN 32	640 [375]	590 [345]	1005 [590]	610 [360]	635 [370]	380 [220]	265 [155]	185 [110]	295 [170]	
1 1/2"	41,9	DN 40	885 [520]	815 [475]	1385 [815]	845 [495]	875 [515]	520 [305]	370 [215]	260 [150]	405 [235]	
2"	53,1	DN 50	1450 [850]	1330 [780]	2265 [1330]	1380 [810]	1430 [840]	855 [500]	605 [355]	425 [250]	665 [390]	
2 1/2"	68,9	DN 65	2480 [1460]	2280 [1340]	3880 [2285]	2365 [1390]	2455 [1445]	1465 [865]	1035 [610]	725 [425]	1140 [670]	
3"	80,9	DN 80	3440 [2025]	3165 [1860]	5380 [3165]	3280 [1930]	3405 [2000]	2035 [1195]	1435 [845]	1010 [590]	1580 [930]	

Flow measuring ranges VA 570 / VA 520 / VA 525													
Inner pipe diameter			High-Speed version (224,0 m/s)										
			Measuring range Nm ³ /h * / [cfm]										
Inch	mm	DN	Corgon ®18	Corgon ®10	Corgon ®20	Forming gas 90% N ₂ + 10% H ₂	Natural gas L (CH ₄)	Biogas 50% CH ₄ + 50% CO ₂	Biogas 60% CH ₄ + 40% CO ₂	LPG 60% C ₃ H ₈ + 40% C ₄ H ₁₀	LPG 50% C ₃ H ₈ + 50% C ₄ H ₁₀	Nitrous (N ₂ O)	Ethyne/ Acetylene (C ₂ H ₂)
1/4"	8,9	DN 8	190 NI/min [6,6]	195 NI/min [6,9]	190 NI/min [6,6]	110 NI/min [3,9]	80 NI/min [2,7]	95 NI/min [3,3]	90 NI/min [3,3]	70 NI/min [2,4]	65 NI/min [2,4]	125 NI/min [4,5]	70 NI/min [2,4]
1/2"	16,1	DN 15	160 [90]	160 [95]	155 [90]	90 [50]	65 [40]	80 [45]	75 [45]	55 [30]	55 [30]	105 [60]	60 [35]
3/4"	21,7	DN 20	310 [185]	320 [185]	310 [180]	180 [105]	135 [80]	155 [90]	150 [85]	110 [65]	110 [65]	210 [120]	120 [70]
1"	27,3	DN 25	520 [305]	530 [310]	515 [300]	300 [175]	225 [130]	255 [150]	250 [145]	190 [110]	185 [105]	345 [205]	200 [115]
1 1/4"	36,0	DN 32	935 [550]	960 [565]	930 [545]	540 [320]	405 [240]	465 [275]	455 [265]	340 [200]	335 [195]	630 [370]	360 [210]
1 1/2"	41,9	DN 40	1290 [760]	1325 [780]	1280 [755]	745 [440]	560 [330]	640 [375]	625 [365]	470 [275]	460 [270]	865 [510]	495 [290]
2"	53,1	DN 50	2115 [1245]	2165 [1275]	2100 [1235]	1225 [720]	920 [540]	1050 [620]	1025 [605]	770 [450]	755 [440]	1420 [835]	810 [475]
2 1/2"	68,9	DN 65	3625 [2130]	3715 [2185]	3595 [2115]	2100 [1235]	1575 [925]	1805 [1060]	1760 [1035]	1320 [775]	1290 [760]	2435 [1430]	1390 [820]
3"	80,9	DN 80	5025 [2955]	5145 [3030]	4985 [2930]	2910 [1710]	2180 [1285]	2500 [1470]	2440 [1435]	1830 [1075]	1790 [1050]	3375 [1985]	1930 [1135]

* Nm³/h according to DIN 1343: 0 °C, 1013,25 hPa for gases

** ISO 1217: 20 °C, 1000 hPa in air

If you want to measure the consumption / flow rate of a specific gas mixture, ask us.
We can offer a real gas adjustment under process conditions on request.

Measure compressed air consumption and save energy

Compressed air is one of the most expensive forms of energy at all. An intelligent use of compressed air holds enormous savings potential.

Therefore a consumption measurement that can measure and record the actual compressed air consumption and even the smallest leaks quickly and reliably is very helpful.



When talking about operating costs in compressed air systems, one actually means the energy costs, because the electricity costs make up about 70-80% of the total cost of a compressed air system.

Depending on the size of the plant this means considerable operating costs. Even in smaller plants this may quickly add up to 10,000 to 20,000 € per year. This is an amount which can be considerably reduced – even in case of well operated and maintained plants.

In case of a three shift operation with 200 kW compressor performance a bad compressed air distribution can create redundant energy costs of more than 50,000 € per year.

This mainly relates to the detection of leaks and the correct design of the compressed air lines to minimize the pressure losses.

Energy resources like electricity, water or gas are usually monitored and therefore the costs are transparent.

Contrary to compressed air, a water leak is usually found quickly due to the visibility of the leak and therefore is fixed immediately. Leakages in the compressed air network „blow out“ unnoticed, even on weekends and during production stops.

Also during that time compressors are running continuously in order to establish a constant pressure within the system. In case of compressed air systems which have grown during the years the leakage rate can be between 25 and 35 per cent.

They are the most industrious consumers working 365 days a year.

Not considered in these considerations are the costs of producing clean and dry compressed air. Refrigeration and desiccant dryers dry the air with significant operating costs, which then „blow out“ useless through leaks.

At constantly rising energy costs these potential energy savings have to be implemented in order to stay competitive within the market. Only if the consumption of single machines or plants becomes known and transparent for all it is possible to make use of possible savings.

However, often there is no knowledge about the leak ratio. In the following we show you how leakage rate can be determined easily in your company.

Formerly the simple but inaccurate container method was applied very often.

A simplified determination of the leakages is possible by means of the emptying of the tank.

To carry out this measurement you just need a clock and a manometer. Furthermore you should know the storage volume of the tank as well as of the compressed air system.

For measurement first the tank and the compressed air system are set to the upper cut-out pressure value. All compressed air consumers have to be switched off.

Then the compressor is switched off and there will be no compressed air feeding into the system.

Now the time T is measured which passes by until there is a pressure drop of 1 to 2 bar due to the leakages.

The pressure drop between which the measurement is taking place can be selected freely.

However, in practice the described method is very time-consuming, not adequate and inaccurate due to the following reasons:

- Storage volume, distribution pipelines cannot be determined exactly
- The accuracy of the differential pressure measurement and time measurement has to be observed
- During pressure drop the compressed air volume cools down and therefore it changes the volume flow reference value
- An online measurement with consumption record is not possible

This method belongs to the so-called indirect measurements, like also the method of the load and unload measurement during which the current intake is measured by means of clamp-on ammeters and calculated back to the volume flow over the technical data of the compressor.

These indirect methods are antiquated and not suitable to detect leakages in the lower measuring range.

Determination of compressed air leakages with modern flow meters

A modern compressed air consumption measurement resp. leakage measurement should be able to measure the real compressed air flow and also the smallest leakages quickly and reliably and record them.

New: Flow measurement DS 400 for compressed air and gases

Worldwide unique with 3.5 inch, graphic display with touch screen and print function.

With the new "ready for plug-in" flow measurement DS 400 the current flow in m³/h, l/min etc. as well as the consumption in m³ or l can be measured.

The new flow station works according to the approved calorimetric measuring principle.



The heart is the flow sensor which has been proven and tested for years.

It is characterized by a new thermally more efficient sensor structure which shows a higher chip temperature in case of same electrical connection values.

Compared to other calorimetric measuring instruments the sensor has a considerably lower mass and therefore a faster response time.

An additional pressure and temperature compensation is not necessary.

The advantage is that the user can use the flow meters in different pressures and temperatures without any further compensation.

Apart from compressed air also other gases like e. g.

- Nitrogen
- Oxygen
- CO₂
- Argon
- Natural gas
- Helium

can be measured.

The flow meter DS 400 is supplied completely wired. There is no need for a time consuming instruction manual reading.

Exceeding of threshold values can be reported optically and acoustically. 2 relays for pre- and main alarm are freely adjustable.

*** Channel A1 ***				- 0.0 V - 0 mA	
Type	VA5xx		VA-Sensor		
Flow	Velocity	Diameter	Unit		
m ³ /h	m/s	53.100	mm		
Gas Constant	Ref. Pressure		Unit		
Air (real)	J/Kg ³ k	1000.00	hpa		
Ref. Temp.	Unit	Count.Val	Unit		
20.000	°C	---			
Back	Store	More-Settings	Info		

An alarm delay can be set for each relay. This grants that only really long-term exceeding of the threshold values are indicated. Additionally every alarm can be reset.

The intuitive operation with the 3.5 inch touch screen graphic display with zoom function and print key is worldwide unique in this price class.

The graphic display with zoom function shows the actual flow, the peak values and the leakage at a glance, the values are stored in the data logger.

So the user can take a look at the stored measuring curves also without any computer at any time on site.

This allows the user to view the stored measured curves without a PC at any time on site.

With the print button, the current screen can be saved as an image file on the internal SD card or on a USB stick and can be printed out without additional software on a PC.

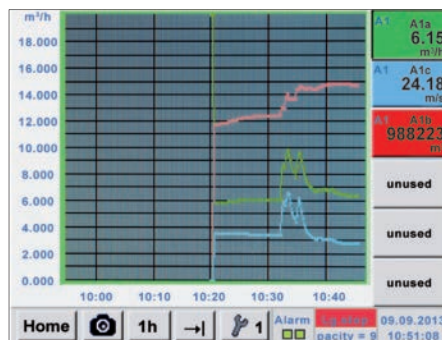

Ideal for documentation of the measured values/ curves on site. Colored measured curves can be sent by e-mail as image files or integrated into a service report.

The internal data logger enables the storage of the measured data for several years. The measured data can be evaluated via a USB stick or via Ethernet by means of the comfortable software CS Soft Basic.

Particularly comfortable is the consumption analysis at the touch of a button. The CS Soft Basic automatically draws up daily, weekly and monthly reports.

Special features

- 3.5" graphic display, intuitive operation via touch screen
- Zoom function for accurate analysis of measured values
- Consumption analysis with daily/weekly/monthly reports
- Colored measured curves with names
- Mathematical calculation function e. g. addition of several consumers to a total consumption or energy costs per kWh/m³
- Print key: Optional indications can be stored as image files directly on a USB stick and sent by e-mail without any software
- 2 alarm contacts for exceeding of threshold values
- Freely adjustable alarm delay for both alarm contacts
- With reset function
- Up to 4 sensor inputs for: Further flow sensors, dew point, pressure, temperature, consumption, active power meters, optional third-party sensors can be
- Connected: Pt100/1000, 0/4..20 mA, 0-1/10 V,
- Modbus, pulse
- Integrated data logger 8 GB
- USB, Ethernet interface, RS 485
- Webserver

Installation under pressure



VA 500 flow meter for compressed air and gases

The VA 500 flow meter is installed via a standard ball valve under pressure. The circlip prevents the instrument from being ejected during installation and removal by the operating pressure.

For the installation at different pipe diameters, the VA 500 can be ordered at special lengths: 120, 160, 220, 300, 400 mm. Therefore it is possible to use the VA 500 flow sensor from inner pipe diameters of 1/2" up to 12" and bigger.

The exact positioning of the sensor is carried out with the aid of the engraved depth scale at the sensors shaft. The maximum insertion depth is therefore determined by the sensor length. Please see picture to determine the sensor length required.

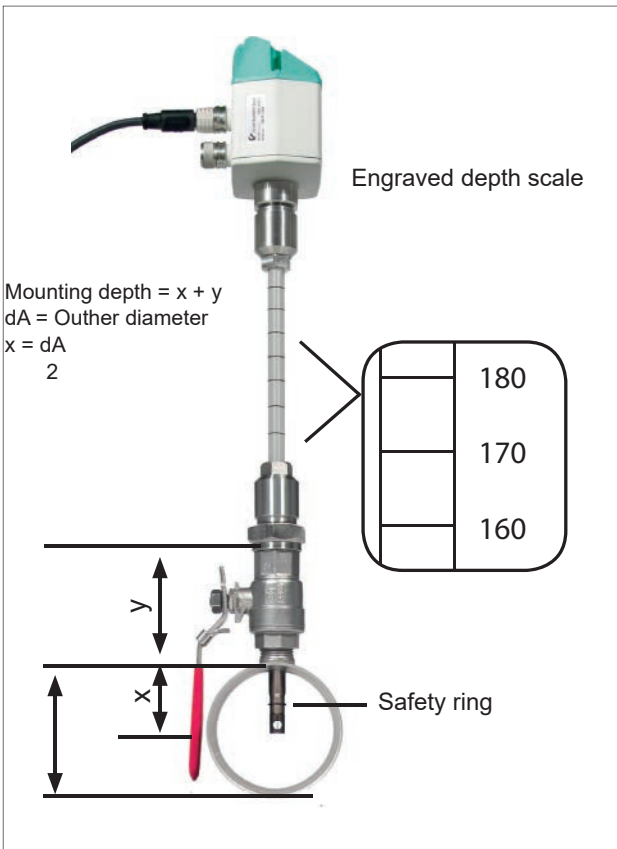

Measuring site

If no 1/2" ball valve is present to carry out the installation of the VA 500 sensor, we have two possible alternatives to offer:

- A** 1/2"-thread needs to be welded onto the pipe work and the ball valve is then threaded on.
- B** A spot drilling collar can be ordered and installed.

Making use of the specialized drilling jig, it is then possible to drill a whole into the pipe work under load. The filings are caught in a special filter system at the drilling jig. Afterwards the VA 500 probe should be installed as described above.

The VA 500 measuring range allows for measurements in almost all possible applications. Even high flow rates in small pipe diameters can be measured.



Measure compressed air quality according to ISO 8573 Residual oil content - particles - moisture



Residual oil content measurement – OIL-Check 400

For permanent and highly precise measurement of the vaporous residual oil content from 0.001 mg/m³ to 2.5 mg/m³. Due to the deep detection limit of 0.001 mg/m³ the compressed air quality class 1 (ISO 8573) can be monitored.

Particle counter PC 400

The highly precise optical particle counter PC 400 measures particles from a size of 0.1 µm and is therefore suitable for monitoring of the compressed air quality class 1(ISO 8573).

Moisture – dew point sensor FA 510

FA 510 measures the pressure dew point down to -80 °Ctd. Also in this case the continuous measurement takes care that alert is triggered immediately if the compressed air dryer breaks down.

DS 500 - the intelligent chart recorder of the next generation

The centerpiece of compressed air quality measurement is the chart recorder DS 500. It measure and documents the measured data of the sensors for residual oil content, particles and moisture. The measured values are indicated on a 7" color screen. The curve progressions from the beginning

of the measurement can be viewed by an easy slide of the finger. The integrated data logger stores the measured values safely and reliably. The threshold value can be freely entered for each measured parameter. 4 alarm relays are available for automatic alarm in case of an exceeding of the threshold values. Optionally DS 500 can be upgraded with up to 12 sensor inputs. For connection to a PLC DS 500

has an Ethernet interface as well as a RS 485 interface. The communication is done via the Modbus protocol.

ISO 8573-1:2010 Class	Solids			Water	Oil
	Maximum number of particles per m ³			Pressure dew point vapor	Totalshare in oil (liquid aerosol and mist) mg/ m ³
	0,1 - 0,5 µm	0,5 - 1 µm	1 - 5 µm		
0	According to determination by the instruments user, more severe requirements than Class 1				
1	<= 20.000	<= 400	<= 10	<= -70 °C	0,01
2	<= 400.000	<= 6.000	<= 100	<= -40 °C	0,1
3	--	<= 90.000	<= 1.000	<= -20 °C	1
4	--	--	<= 10.000	<= +3 °C	5
5	--	--	<= 100.000	<= +7 °C	--
6	--	--	--	<= +10 °C	--
7	--	--	--	--	--
8	--	--	--	--	--
9	--	--	--	--	--
X	--	--	--	--	--



Stationary solution

DESCRIPTION	ORDER-NO.
DS 500 – intelligent chart recorder in basic version (4 sensor inputs)	0500 5000
CS Basic - data evaluation in graphic and table form - readout of the measured data via USB or Ethernet. License for 2 working places	0554 8040
Residual oil measurement: OIL-Check 400 – residual oil content measurement of the vaporous residual oil content from 0.001...2,5 mg/m ³ , 3...16 bar. Highly precise PID sensor, integrated mini catalyst for zero point calibration, without integrated display, with analogue output 0...10 Volt for connection to an external chart recorder.	0699 0070
Sampling system OIL-Check 400: Sampling system consisting of ½" ball valve (oil- and grease-free), 1 m stainless steel tube 6x1 mm (oil- and grease-free), clamp screwing (oil- and grease-free)	Z699 0075
Alternative: Portable sampling system consisting of 2 m PTFE hose, quick-lock coupling (oil- and grease-free)	Z699 0074
Options for systems > 16 bar: Pressure reducer (oil- and grease-free), input pressure max. 300 bar, output pressure up to 10 bar	Z699 0076
Connection cable for probes, 5 m with open ends	0553 0108
PC 400 particle counter up to 0.1 µm for compressed air and gases, incl. pressure reducer/sampling hose/ calibration certificate, Modbus-RTU interface	0699 0040
Connection cable for probes, 5 m with open ends	0553 0108
FA 510 dew point sensor for adsorption driers -80°...+20°Ctd incl. inspection certificate, 4...20 mA analogue output (3-wire technology) and Modbus-RTU interface	0699 0510
Standard measuring chamber up to 16 bar	0699 3390
Connection cable for VA/FA Series, 5 m	0553 0104

Mobile solution with DS 500 mobile, OIL-Check 400, PC 400, FA 510



DESCRIPTION	ORDER-NO.
DS 500 mobile - intelligent chart recorder with 4 sensors inputs	0500 5012
CS Basic - data evaluation in graphic and table form - readout of the measured data via USB or Ethernet. License for 2 working places	0554 8040
Residual oil measurement: OIL-Check 400 – residual oil measurement of the vaporous residual oil content from 0.001...2.5 mg/m ³ , 3...16 bar. Highly precise PID sensor, integrated mini catalyst for zero point calibration, without integrated display, with analogue output 0...10 Volt for connection to external chart recorders	0699 0070
Mobile transport trolley including roles (outer dimensions: 1.0 x 0.7 x 0.35 m (W x H x D) with firmly mounted components of OIL-Check 400, PC 400, FA 510	0554 6017
Mobile sampling system consisting of 2 m PTFE hose, quick lock coupling (oil- and grease-free)	Z699 0074
Connection cable for pressure, temperature, third party sensors to portable devices, ODU / open ends, 5 m	0553 0501
PC 400 particle counter up to 0.1 µm for compressed air and gases, incl. pressure reducer/ sampling hose, calibration certificate, Modbus-RTU interface	0699 0040
Connection cable for probes, 5 m with open ends	0553 0501
FA 510 dew point sensor, -80°...+20°Ctd, incl. mobile measuring chamber and 5 m connection cable to portable devices	0699 1510



OIL-Check 400

The monitoring system for permanent highly precise measurement of the vaporous residual oil content in compressed air



The advantage at a glance:

- Permanent, highly precise residual oil measurement (oil vapor) with PID sensor (photo-ionic-detector)
- Ideal for mobile measurement: The PID sensor is ready for measurement within about 30 minutes
- Long-term stable measuring results due to automatic zero-point calibration. The integrated mini catalyst reliably generates a defined reference gas for zero-point calibration
- Contrary to measuring systems which generate the "zero air" resp. reference gas by means of active carbon filters and which are there fore depending on the ageing and the saturation of the active carbon filters, the mini catalyst generates the "zero air" without ageing or wear. There is no change of active carbon filters necessary
- Easy sampling via PTFE hose or stainless steel pipe

Integrated chart recorder DS 400:

- Data logger for long-term monitoring
- Display shows trend curves (online and history curves are available)
- Zoom function directly at the touch screen
- Integrated Ethernet interface (Modbus/TCP) and RS 485 interface (Modbus-RTU) for data transfer to a PLC
- 2 alarm relays (changeover contact 230VAC, 3A) - threshold values freely adjustable
- Easy operation via 3.5" touch screen

TECHNICAL DATA OIL-CHECK 400

Measuring medium:	Compressed air, free from aggressive, corrosive, acid, toxic, flammable and oxidizing components.
Measuring unit:	Residual oil content in mg oil/norm m ³ referred to 1.0 bar [abs], +20° C, 0% relative humidity, according to ISO 8573-1
Identifiable substances:	Hydrocarbons, functional hydrocarbons, aromatic hydrocarbons
Application points:	After activated carbon filter, after activated carbon adsorber, after oil-free compressor, always with connected upstream filtration and dryer
Ambient temperature:	+5 °C... +45 °C, rel. humidity <= 75% without condensation
Pressure dew point:	max. +10 °Ctd.
Compressed air temp.:	+5 °C.... +50 °C,
Operational overpressure:	3...16 bar [g] optionally pressure reducer connected upstream for up to 300 bar [g]
Setting operational pressure:	By means of integrated pressure reducer with display
Humidity of measured gas:	<= 40% rel. humidity, pressure dew point max. +10 °C, non-condensable humidity
Compressed air connection:	G 1/8" inner thread according to ISO 228-1
Measured values:	mg/Norm m ³ , pressure and temperature compensated, residual oil vapor content
Measuring range:	<= 0.001 ... 2.5 mg/m ³
Detection limit (residual oil):	0,001 mg/m ³
Measuring range and accuracy:	≤ 0.01 ... 0.5 mg/m ³ ± 0,003 ≤ 0.5 ... 1.0 mg/m ³ ± 0,10 ≤ 1.0 ... 2.5 mg/m ³ ± 0,10
Flow of measuring gas:	~ 1.20 norm liters/minute, referred to 1.0 bar [abs] and + 20 °C, in ambient condition
Reference gas generation:	By means of integrated mini catalyst
Power supply:	100...240 VAC / 1 Ph. / PE / 50...60 Hz / ± 10%
Outputs:	Ethernet interface (Modbus/TCP) RS 485 interface (Modbus-RTU) 2 alarm relays (change 230 VAC 3A) 4...20 mA (on request)
Operation hours counter:	integrated
Dimensions (mm):	410 x 440 x 163 (W x H x D)
Weight:	approx. 16.3 kg

OIL-Check 400 - Stationary solution



DESCRIPTION	ORDER-NR.
OIL-Check 400 – residual oil content measurement of the vaporous residual oil content from 0.001...2,5 mg/m ³ , 3...16 bar. Highly precise PID sensor, integrated mini catalyst for zero point calibration, without integrated display, with analogue output 0...10 Volt for connection to an external chart recorder	0699 0070
Option: DS 400 chart recorder integrated in the OIL-Check 400	Z699 0071
Sampling OIL-Check 400: Sampling system consisting of ½“ ball valve (free of oil and grease), 1 m stainless steel tube 6x1 mm (free of oil and grease), clamp screwing (free of oil and grease)	Z699 0075
Portable sampling system consisting of 2 m Teflon hose, quick-lock coupling (free of oil and grease)	Z699 0074
for systems > 16 bar: Pressure reducer (free of oil and grease), input pressure max. 300 bar, output pressure up to 10 bar	Z699 0076
Option for DS 400:	
Integrated data logger for 100 million measured values	Z500 4002
Integrated Ethernet and RS 485 interface	Z500 4004
Integrated Webserver	Z500 4005
2 additional sensor inputs for analogue sensors (pressure sensors, temperature sensors and so on)	Z500 4001
CS Basic - data evaluation in graphic and table form - readout of the measured data via USB or Ethernet. License for 2 working places	0554 8040

OIL-Check 400 - Portable solution with handle



Carrying handle and stand



Flight case

DESCRIPTION	ORDER-NR.
OIL-Check 400 – residual oil measurement of the vaporous residual oil content from 0.001...2.5 mg/m ³ , 3...16 bar. Highly precise PID sensor, integrated mini catalyst for zero point calibration. Without integrated display, with alarm output 0...10 Volt for connection to external chart recorder	0699 0070
Option:	
DS 400 chart recorder integrated in the OIL-Check 400	Z699 0071
Handle and pedestal for mobile use of the OIL-Check 400	Z699 0072
Flight case for OIL-Check 400	Z699 0073
Mobile sampling system consisting of 2 m PTFE hose, quick lock coupling (oil- and grease-free)	Z699 0074
Options for DS 400:	
Integrated data logger for 100 million measured values	Z500 4002
Integrated Ethernet and RS 485 interface	Z500 4004
Integrated Webserver	Z500 4005
2 additional sensor inputs for analogue sensors (pressure sensors, temperature sensors and so on)	Z500 4001
CS Basic - data evaluation in graphic and table form - readout of the measured data via USB or Ethernet. License for 2 working places	0554 8040



DESCRIPTION	ORDER-NR.
Replacement unit OIL-Check for the period of re-calibration	0699 3910
Replacement unit OIL-Check incl. DS 400 for the period of re-calibration	0699 3920
Re-calibration OIL-Check incl. certificate	0699 3301
Re-calibration and maintenance OIL-Check incl. certificate, rate 1 for up to 8760 hours of operation	0699 3302
Re-calibration and maintenance OIL-Check incl. certificate, rate 2 for over 8760 hours of operation	0699 3303



Particle counter PC 400 and DS 400

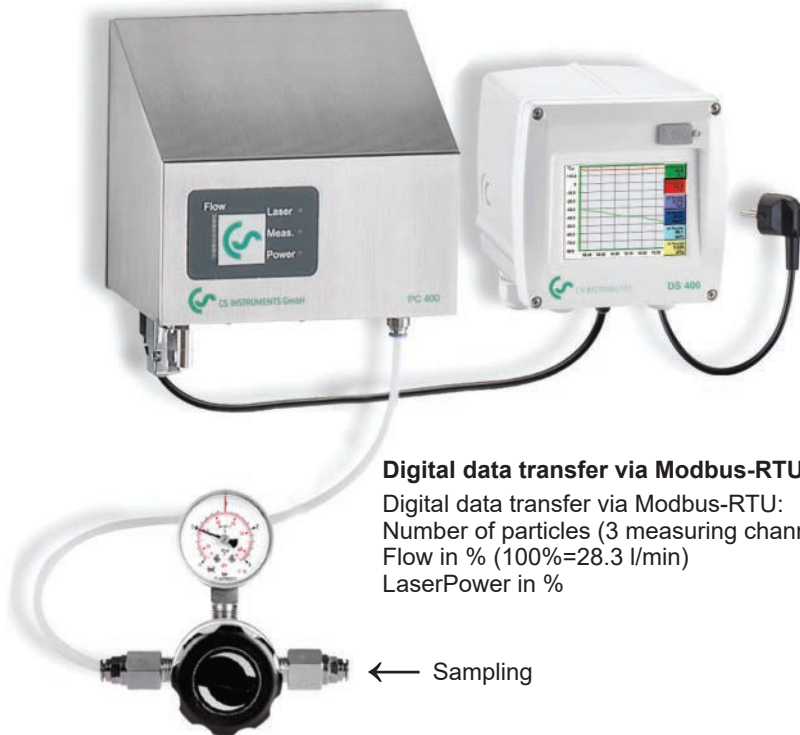

Digital data transfer via Modbus-RTU:

Digital data transfer via Modbus-RTU:
Number of particles (3 measuring channels)
Flow in % (100%=28.3 l/min)
LaserPower in %

The DS 400 shows all 3 measuring channels according to ISO 8573-1

Particle size 0.1...0.5 µm: Number of particles per m³

Particle size 0.5...1.0 µm: Number of particles per m³

Particle size 1.0...5.0 µm: Number of particles per m³

A1a	PC 400	0.1-0.5µ	1458 cts/m ³
A1b	PC 400	0.5-1.0µ	459 cts/m ³
A1c	PC 400	1.0-5.0µ	388 cts/m ³
Home		Setup	Alarm Lg.stop 10.01.2012 1 days, ... 22:34:33

The advantages at a glance:

- Highly precise optical laser particle counter for the use in compressed air and technical gases
- Highly precise optics for detection of smallest particles up to 0.1 µm and therefore it is suitable for monitoring of the compressed air class 1 according to ISO 8573-1. The flow rate of 28.3 l/min (1 cfm) is 10 times higher than the one of the generally available particle counters (2,83 l/min). Advantage: It counts smallest particles at simultaneously high counting accuracy
- Due to the digital data transfer (Modbus-RTU) to the chart recorders DS 400 / DS 500, 3 measuring channels can be transferred at the same time (without any faults due to check sum)
- The class 1 filter which is included in the scope of delivery can be used for on-site calibration at any time. So pollutions at the optics can be recognized resp. excluded quickly

The advantages of DS 400

- Data logger for long-term monitoring
- Display shows trend curves (online and history curves available)
- Zoom function directly at the touch screen
- Integrated Ethernet interface (Modbus/TCP) and RS 485 interface (Modbus-RTU) for data transfer to a PLC
- 2 alarm relays (changeover contact 230 VAC, 3A) threshold values freely adjustable
- Easy operation via 3.5" touch screen

TECHNICAL DATA PC 400

Measuring medium: Compressed air, free from aggressive, corrosive, acid, toxic, flammable and oxidizing components as well as gas types like N₂, O₂, CO₂ Further gas types on request

Application points: In case of compressed air after filtration
In case of gases / pure gases also without filtration

Measuring unit: Number of particles per m³ (referred to ambient air: 20°C, 1000 hPa)

Size channels of PC 400 0.1 µm:

Particle size 0.1...0.5 µm: number of particles per m³

Particle size 0.5...1.0 µm: number of particles per m³

Particle size 1.0...5.0 µm: number of particles per m³

Size channels of PC 400 0.3 µm:

Particle size 0.3...0.5 µm: number of particles per m³

Particle size 0.5...1.0 µm: number of particles per m³

Particle size 1.0...5.0 µm: number of particles per m³

Operating pressure: Max. input pressure at pressure reducer: 40 bar

Humidity of meas. gas: ≤ 90% rel. humidity, pressure dew point max. 10°Ctd, non-condensable humidity

Comp. air connection: 6 mm PTFE hose incl. quick-lock coupling

Flow rate: 28,3 l/min (1 cfm)

Interface: RS 485 (Modbus-RTU)

Light source: Laser diode

Power supply: 24 VDC, 300 mA

Dimensions: 150 x 200 x 300 mm

Weight: 8 kg

Housing: Stainless steel

Stationary solution with particle counter PC 400 and DS 400



DESCRIPTION	ORDER-NR.
PC 400 particle counter up to 0.1 µm for compressed air and gases, incl. pressure reducer and calibration certificate	0699 0040
Connection cable for probes 5 m, with open ends	0553 0108
DS 400 chart recorder with graphic display and touch screen operation	0500 4000 D
Option:	
Integrated data logger for 100 million measured values	Z500 4002
Integrated Ethernet and RS 485 interface	Z500 4004
CS Basic - data evaluation in graphic and table form - readout of the measured data via USB or Ethernet. License for 2 working places	0554 8040
As an alternative to PC 400 up to 0,1 µm: PC 400 particle up to 0,3 µm for compressed air and gases, incl. pressure reducer and calibration certificate	0699 0041

Mobile solution with particle counter PC 400 in a service case and DS 500 mobile



DESCRIPTION	ORDER-NR.
PC 400 particle counter for up to 0.1 µm for compressed air and gases incl. pressure reducer and calibration certificate in a service case	0699 0042
Connection cable for third party sensors to portable devices, ODU/open ends, 5 m	0553 0501
Chart recorder DS 500 mobile, 4 sensor inputs	0500 5012
CS Basic - data evaluation in graphic and table form - readout of the measured data via USB or Ethernet. License for 2 working places	0554 8040
Alternative to PC 400 to 0.1 µm:	
PC 400 particle counter up to 0.3 µm for compressed air and gases, incl. pressure reducer, incl. calibration certificate in service case	0699 0043

Re-calibration of particle counter



DESCRIPTION	ORDER-NR.
Re-calibration of particle counter PC 400 incl. certificate	0699 3304

LD 500/510 - Leak detector with camera - indicates leakage rate in l/min and costs in €

The LD 500 meets the requirements of Class I „Standard Test Method for Leaks with ultrasound“ (ASTM Int. - E1002-5)



Find out your leak rate (l/min) and potential saving (€/year)



Find the smallest leaks in far distance



Auto level: adapts the sensitivity automatically to the environment and eliminates the ambient noise reliably



Photograph leaking parts



Describe the leak and necessary actions



Transmit the leak details via USB to your desktop software



Create an ISO 50001 report



Seek the leak the whole day (9 hours)

Costs per year						
Pressure	Leak size - Diameter (mm)					
	0,5 mm	1,0 mm	1,5 mm	2,0 mm	2,5 mm	3,0 mm
3 bar	90 €	361 €	812 €	1.444 €	2.256 €	3.248 €
4 bar	113 €	451 €	1.015 €	1.805 €	2.820 €	4.061 €
5 bar	135 €	541 €	1.218 €	2.166 €	3.384 €	4.873 €
6 bar	158 €	632 €	1.421 €	2.527 €	3.948 €	5.685 €
7 bar	180 €	722 €	1.624 €	2.888 €	4.512 €	6.497 €
8 bar	203 €	812 €	1.827 €	3.248 €	5.076 €	7.309 €

Table: Leakage costs within one year in case of operation 24 h/365 days, calculated with compressed air costs of 1.9 ct/Nm³.

LD 500/510 is a consistent advancement

The new leak meters LD 500/510 with integrated camera and leakage calculation are ideal measuring instruments which help to find and document even smallest leakages (0.1 l/min corresponds to approx. 1 € per year) easily even in far distances.

LD 510 is the worldwide first leak meter with an additional freely assignable sensor input for all CS sensors. In addition to the leakage measurement and detection also all necessary measurements with regards to dew point, flow, pressure, and temperature ... can be carried out.

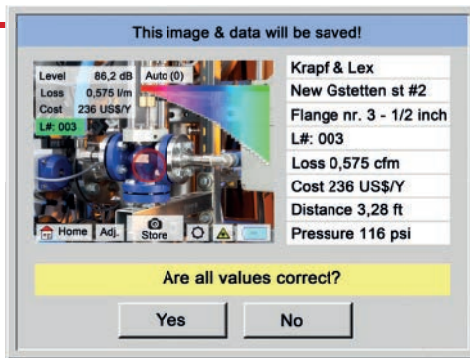

Leak detection at:

- Compressed air, gas, steam and vacuum systems
- Steam Traps
- Seals



The noise-proof headset enables the leak detection also in EXTREMELY loud ambient. The ambient noise will be faded out, the leakage (inaudible ultrasonic sound) will be transformed to an audible signal. The laser grants an exact locating.

Accessories



Acoustic trumpet

bundles the acoustic waves of smallest leakages, disturbing ambient noise will be eliminated



Focus tube with focus tip for precise locating of smallest leakages in narrow areas



Optionally available:

Gooseneck enables a positioning of the leakage on the spot – even in case of hardly accessible locations. Noise is hidden.



Parabolic mirror:

for leak detection at long distances. Laser pointer and camera integrated.

Professional accessory parabolic mirror

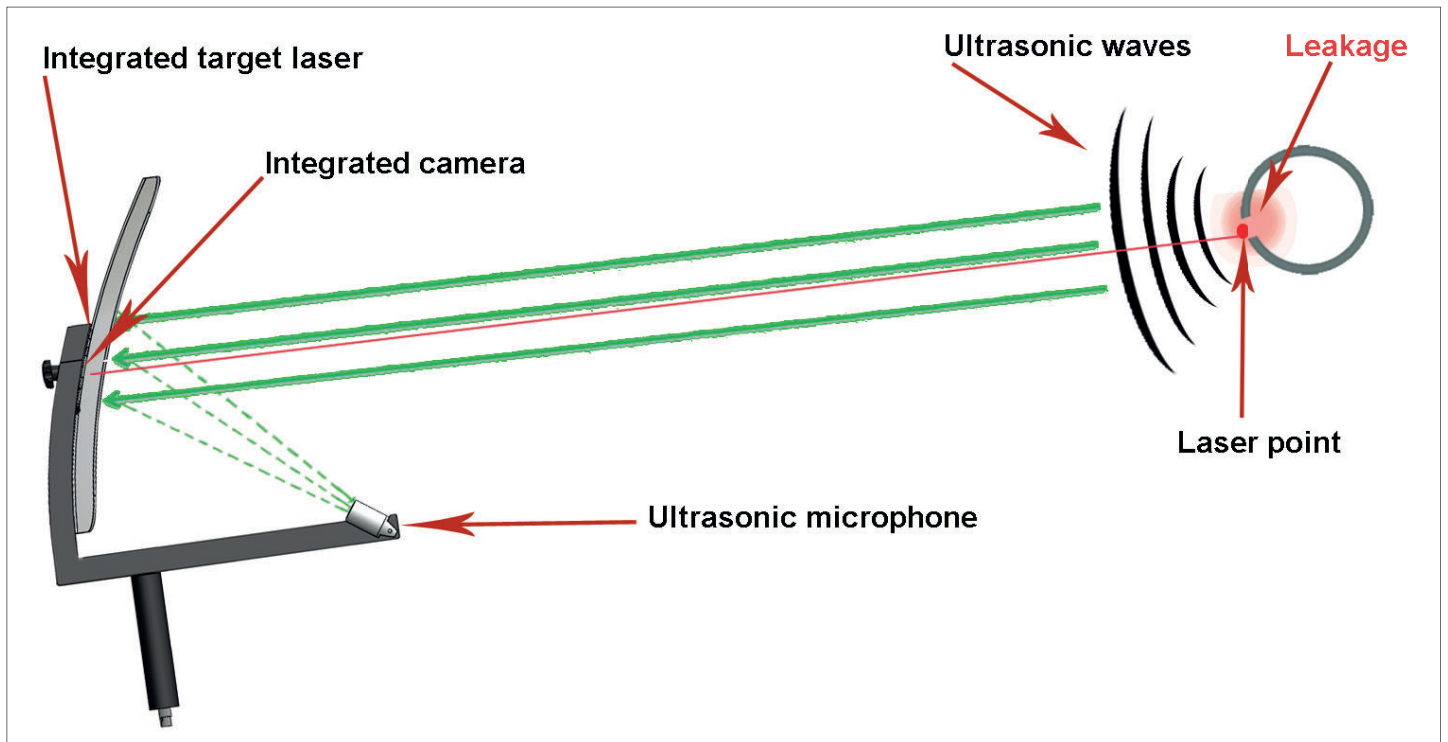

By bundling the ultrasonic waves in the parabolic mirror, even the smallest leaks of 0.8 l / min (ca. 8 € p.a.) at a distance of up to 10 ... 15 m can be localized with pinpoint accuracy (± 15 cm). The shape of the parabolic mirror ensures that only ultrasonic waves of the targeted leak are evaluated. Disterbing noise is reduced to a minimum.



Accurate leak detection during operation with laser pointer and integrated camera



Checking high voltage overhead lines for corona discharge



Leakage files stored in LD 500 are exported to a USB stick for issuing a report by software

If the leakage is detected and stored, the following data are also stored in the LD 500 and will be available after the export to the CS Leak Reporter software to issue a report:

- Photo of the leakage
- Date / time
- Company name / department / machine
- Size of the leakage in liters/min (unit selectable)
- Costs of the leakage per year in € (currency selectable)

Detailed reports can be issued via PC software, which can be placed at the disposal of the operators of compressed air systems resp. the head of the respective department.

The report can be issued for the whole company or for each department and it documents the detected leakages easily and clearly. Due to the summation at the end of the report it is easy to get an overview on the whole leakage amount in liters/min as well as the total leakage costs per year.

LEAK TAG
DO NOT REMOVE!

Leak Tag number:

Date / Datum:	
Inspector / Prüfer:	
Defective element / Defektes Element:	
Priority / Priorität:	high <input type="checkbox"/> low <input type="checkbox"/>
Loss / Verlust:	
Costs per year / Kosten p.a.:	
Date repaired / Repariert am:	
Repaired by / Repariert durch:	

www.cs-instruments.com

Leak Tag number:

Date / Datum:	
Inspector / Prüfer:	
Defective element / Defektes Element:	
Location / Ort:	
Gas Type / Medium:	
Priority / Priorität:	high <input type="checkbox"/> low <input type="checkbox"/>
Loss / Verlust:	
Costs per year / Kosten p.a.:	

www.cs-instruments.com

Leak Tags in hardcopies for documentation on-site









Leakage - report for ISO 50001 Audits

Int. Compressor Service 

Company: Krapf + Lex
Project: Datenimport 2018-04-04T09:34:51.861Z
Report created at: 04.04.2018 11:52
from: Matthew Smith

Leakages

Project master data:
costBase: 19.00 €
costTime: 8760

Image	Building Place LeakTag	Date Time	Volume loss	Costs / Year	CO2 Tons / Year	Comment action measures Responsible	Status	Priority
	Neuer Gasettenweg 2 Flansch Nr. 3 - DN 15 003	04.04.2018 11:29:42	10.549 l/min	105.35 €	0.58	SEALING		
	Neuer Gasettenweg 2 Machine 23 004	04.04.2018 11:31:19	21.528 l/min	214.99 €	1.19	Coupling		
	Neuer Gasettenweg 2 Machine 23 005	04.04.2018 11:32:51	2.987 l/min	29.83 €	0.17	Piping		
			Σ 35.06 l/min	Σ 350.17 €	Σ 1.94			

DESCRIPTION	ORDER NO.
Set LD 500 consisting of:	0601 0105
LD 500 leak detector with acoustic trumpet, and integrated camera, 100 leak tags for marking the leakages on site	0560 0105
Transportation case	0554 0106
Sound-proof headset	0554 0104
Focus tube with focus tip	0530 0104
AC adapter plug	0554 0009
Helix cable for connecting the ultrasonic sound sensor, length 2 m, (extended)	020001402
Set LD 510 consisting of:	0601 0106
LD 510 leak detector incl. acoustic trumpet, with integrated camera and additional input for external sensors, 100 leak tags for marking the leakages on site	0560 0106
Transportation case	0554 0106
Sound-proof headset	0554 0104
Focus tube with focus tip	0530 0104
AC adapter plug	0554 0009
Helix cable for connecting the ultrasonic sound sensor, length 2 m, (extended)	020001402
Equipment:	
CS Leak Reporter – for detailed ISO 50001 reports. Gives an illustrated survey of the found leakages and their possible savings. Measures for elimination including status display can be defined for every leakage - License for 2 computers	0554 0105
Gooseneck for leakage detection at sites which are difficult to access (length 600 mm)	0530 0105
Gooseneck for leakage detection at sites which are difficult to access (length 1500 mm)	0530 0108
Parabolic mirror for leak detection at long distances, incl. Transportation case	0530 0106
Ultrasonic tone generator for leak testing	0554 0103
500 leak tags for marking the leakages on site	0530 0107
Calibration:	
Recalibration LD 500 / LD 510	0560 3333
Further sensors / accessories for connection to LD 510:	
FA 510 dew point sensor for mobile devices, -80...+20°Ctd, incl. mobile measuring chamber, 5 m connection cable and perforated protection cap	0699 1510
Flow sensor VA 500, Max version (185 m/s) sensor length 220 mm, incl. 5 m connection cable	0695 1124
Standard pressure sensor CS 16, 0...16 bar, ± 1 % accuracy of f. s	0694 1886
Differential pressure sensor 1.6 bar diff.	0694 3561
Connection cable for pressure, temperature or external sensors on mobile instruments, ODU / open ends, 5 m	0553 0501
CS Basic - data evaluation in graphic and table form - reading out of the measured data via USB Stick or Ethernet. License for 2 computers	0554 8040



Transportation case LD 500/510



Transportation case with Parabolic mirror

TECHNICAL DATA LD 500 / LD 510	
Working frequency:	40 kHz ± 2 kHz
Connections:	3.5 mm stereo jack for headset Power supply socket for connecting an external recharger
Laser:	Wave length: 645...660 nm Output power: < 1 mW (laser class 2)
Display:	3,5" Touch screen
Interface:	USB interface
Data logger	8 GB SD memory card (100 million values)
Power supply:	Internal rechargeable Li-Ion batteries approx. 9 h continuous operation, 4 h charging time
Ambient temperature:	0...+50°C
EMC:	DIN EN 61326
Auto level:	Adapts the sensitivity automatically to the environment and eliminates the ambient noise reliably
Sensitivity:	min: 0.1 l/min at 6 bar, 5 m distance, approx. 1€/year compressed air costs

TECHNICAL DATA EXTERNAL SENSOR INPUT (ONLY LD 510)	
Measuring range:	Please see external CS sensors
Accuracy:	Please see external CS sensors
Voltage supply:	Output voltage: 24 VDC ± 10% Output current: 120 mA in continuous operation

Leak detector LD 400

If gases escape through leaks in piping systems (e.g. untight screwed connections, corrossions and so on) ultrasonic noises are generated. By means of LD 400 even the smallest leakages which cannot be heard by the human ear and which are not visible due to their size can be detected even from distances of

several meters. LD 400 transforms the inaudible signals into a frequency which can be identified. By means of the comfortable sound-proof headset these noises can be realized even in extremely noisy environments.

The LD 400 leak detector is the advancement of the proven LD 300 and it convinces

by its obviously refined sensor technology and its improved support in the tracing of leaks.

By means of the integrated laser pointer which serves for target heading the leak can be localized more accurately.



Applications

Leak detection in:

- Compressed air lines, gas, vapor and vacuum plants
- Door seals



LD 400 with focus tube and focus tip for precise locating.



↑
Acoustic trumpet

Sound-proof headset enables:
leak detection in extremely noisy environments

Costs per year						
Pressure	Leak size - Diameter (mm)					
	0,5 mm	1,0 mm	1,5 mm	2,0 mm	2,5 mm	3,0 mm
3 bar	90 €	361 €	812 €	1.444 €	2.256 €	3.248 €
4 bar	113 €	451 €	1.015 €	1.805 €	2.820 €	4.061 €
5 bar	135 €	541 €	1.218 €	2.166 €	3.384 €	4.873 €
6 bar	158 €	632 €	1.421 €	2.527 €	3.948 €	5.685 €
7 bar	180 €	722 €	1.624 €	2.888 €	4.512 €	6.497 €
8 bar	203 €	812 €	1.827 €	3.248 €	5.076 €	7.309 €

Table: Leakage costs within one year in case of operation 24 h/365 days, calculated with compressed air costs of 1.9 ct/Nm³.

Through the use of a specially designed trumpet, a better bundling of the sound waves is achieved. This trumpet acts like a directional microphone, suppressing unwanted noise and facilitating the pinpoint location of leaks even in hard-to-reach areas. Due to the special design of the bell, the use of the laser pointer is not hin-

dered. A handy ultrasonic transmitter is available for detecting leaks in pressureless systems. The transmitter is positioned so that the sound can enter the piping system. The ultrasonic signal penetrates the smallest openings, which can then be detected with the LD 400.

Even very small leaks at hatches, doors and windows can be detected.

Special features

- Robustness and low weight ensure fatigue-free use in industrial environments
- Improved detection of leaks with optional acoustic trumpet
- Modern lithium-ion battery with high capacity, external recharger
- Minimum operating time 10 h
- Easy operation via keypad



LD 400 is available either as standalone device or in a complete set. The set includes a robust impact-proof transportation case which contains all necessary components and accessories.

DESCRIPTION	ORDER-NR.
Set LD 400 consisting of:	0601 0104
LD 400 Leak detector	0560 0104
Transport case	0554 0106
Sound-proof headset	0554 0104
Focus tube with focus tip	0530 0104
Battery charger	0554 0009
Acoustic trumpet	0530 0109
Accessory, not included in the set:	
Ultrasonic tone generator	0554 0103

TECHNICAL DATA LD 400	
Working frequency:	40 kHz ± 2 kHz
Connections:	3.5 mm stereo jack for headset. Power supply socket for connecting a external recharger
Laser:	wave length: 645...660 nm output power: < 1 nW (laser class 2)
Operating duration:	10 hours
Charging time:	approx. 1.5 hours
Operating temp.:	0 to 40 °C
Storage temp.:	-10 °C to 50 °C

CS Basic

With the CS Basic the paperless recorder DS 500/400 and all mobile devices with data logger can be read out. Depending on the device, data transfer is done either via USB stick or Ethernet connection.

CS Network

The CS Network is a client-server solution. The server software automatically collects the data of all CS paperless recorders and CS sensors embedded in the company's computer network and stores them in a database. The evaluation / analysis of the measured data is carried out via the evaluation software (client) at any number of workstations.

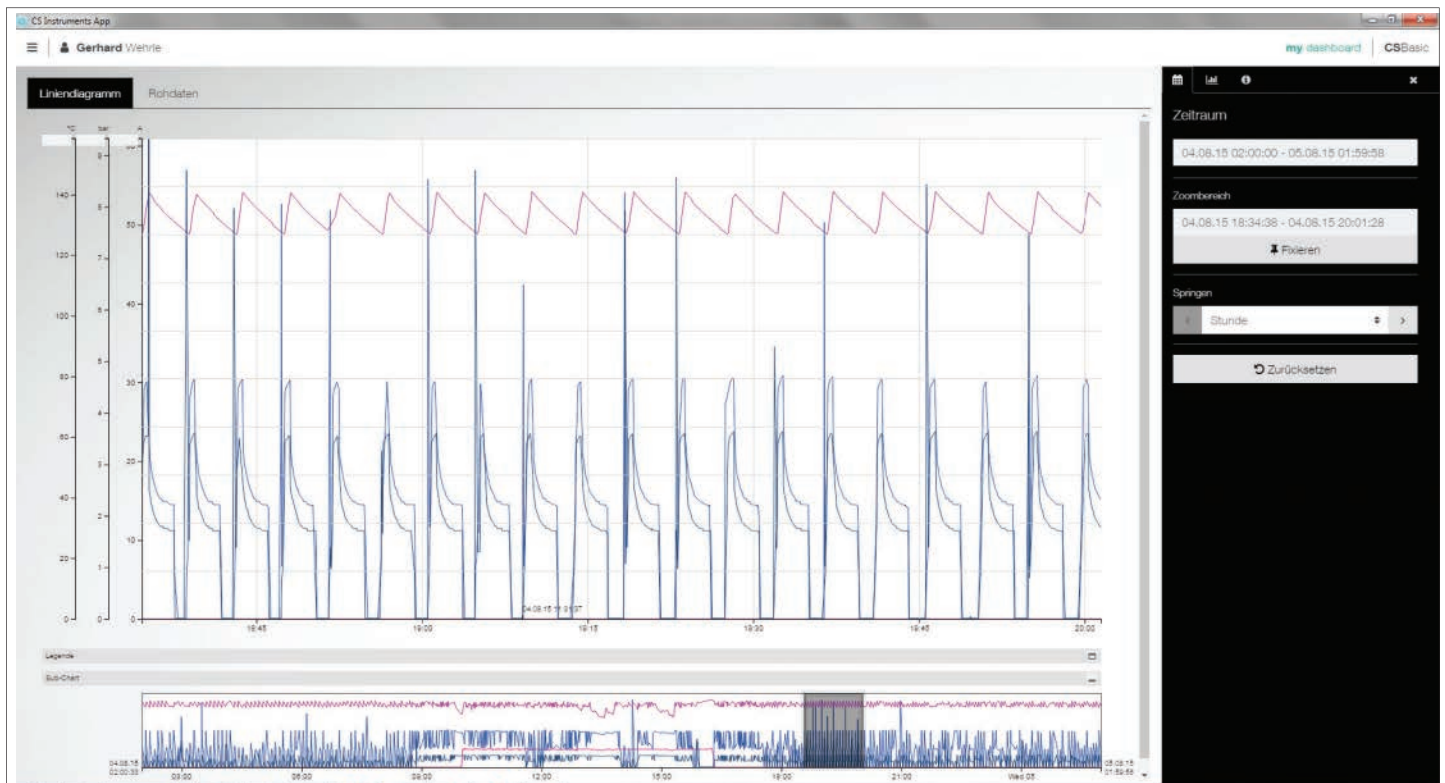

	CS Basic	CS Network
Installation	Local PC installation	Server (virtual machine) Client (Browser-based)
Data storage	Database (local)	Database (Server, virtual machine)
Updates to new releases free of charge	Yes	Yes
Automatic information about upgrades	Yes (only in case of internet access)	Yes
Number of working place licenses	2	Unlimited
Number of measured values	All measured values transmitted by a device. (Max. 1 device at the same time)	Up to 20 / up to 50 / up to 100 / up to 200 measured values
Data transfer	USB Stick (manually) or Ethernet	Ethernet
User administration	No	Yes
E-Mail in case of threshold value exceeding	No	Yes
Storage of the measured data	Logger data have to be read-out manually via CS Basic	CS Network automatically stores the measured data of all connected devices

Common functions:

Graphic evaluation

All measuring curves are indicated in color. All necessary functions are integrated, like e. g. free zoom, selection/deselection of single measuring curves, free selection of periods, scaling of the axis, select colors and so on.
This view can be stored as a PDF file and sent by e-mail. Different data can be combined in one common file.

Table view

All measuring points are listed with exact time interval. The desired measuring channels with the name of the measuring place can be selected via the diagram explorer.

Statistics

All required statistic data are visible at a glance. So the user can see very quickly which minimal or maximal measured values occurred when and for how long.

Consumption report

The software issues a consumption report for all connected flow sensors, it can be selected if it should be daily, weekly or monthly.

Data export to MS-Excel® or csv

The measured data can be exported to Excel or csv.

Tariffes

The price per consumption unit can be stored for each energy form. Depending on the time and the day different tariffs can be stored. The validity of the tariffs can be defined via calendar function in order to grant that price increased resp. decreases can be updated.

Multi lingual

German, english and further languages are included in the scope of delivery.

Alarm history / Alarm logfile

The exceeding of the limit values is documented with the CS Network.

Administration of the measuring sites

Each CS sensor resp. each CS chart recorder can be allocated to a department/hall (resp. cost centers).

Optional add-on modules:

Module „formular-editor“

By means of the formula editor e. g. the measured values of 2 sensors can be totaled or subtracted from each other.



CS Basic

Data evaluation for mobile measurement:

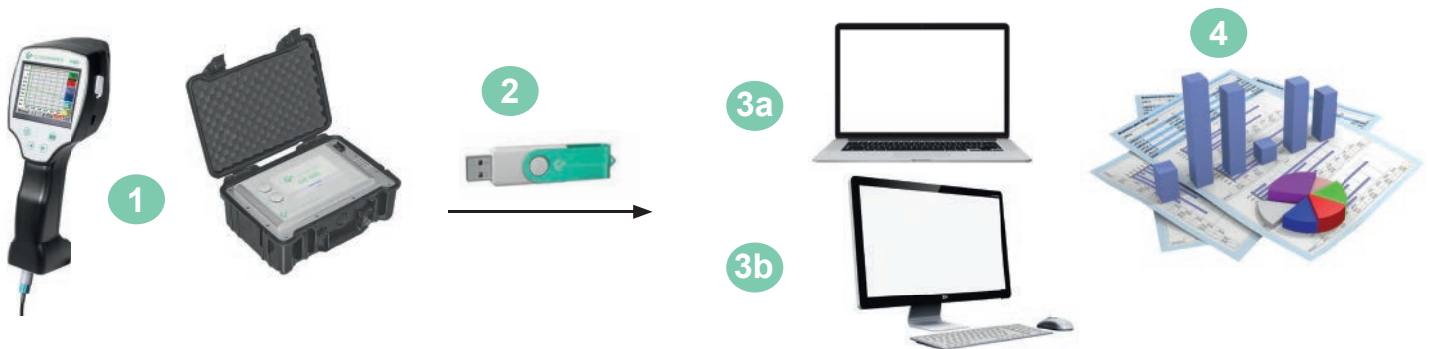

- 1 Mobile measurement at the customer. Measured data are saved in the data logger in the selected measuring cycle
- 2 Export of the data to the USB stick
- 3a Import of the measured data to the laptop directly on-site
- 3b Import of the measured data to the computer in the office
- 4 Evaluation and print out of the measured data

Data evaluation for fix installed chart recorder in the company:

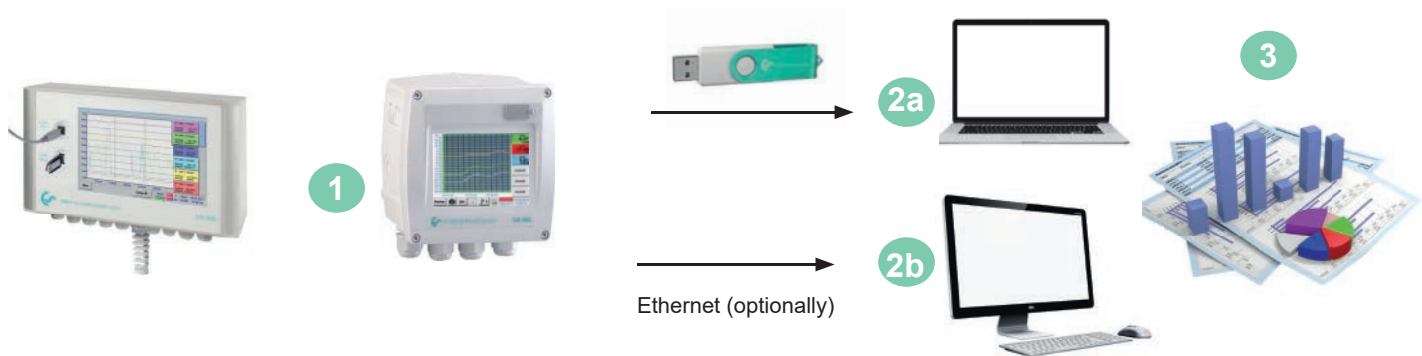

- 1 Chart recorder is fix installed in the company. Measured data will be saved in the data logger in the selected measurement cycle
- 2a Transfer the data via USB stick to the computer
- 2b Readout of the logger data via the computer network (LAN) by means of CS Basic
- 3 Evaluation and print out of the measured data

DESCRIPTION	ORDER-NR.
CS Basic - data evaluation in graphic and table form - readout of the measured data via USB or Ethernet. License for 2 working places	0554 8040
Additional license for 1 further working place	Z554 8040
Module „Formula Editor“ – by means of the formula editor the measured data and constants can be calculated (addition, subtraction, division, multiplication, root function, exponentiation)	Z554 8010
Upgrade CS Soft Basic (0554 7040) to CS Basic (0554 8040). CAA module is not available any more. Please state old license key when ordering	Z554 8041

CS Basic

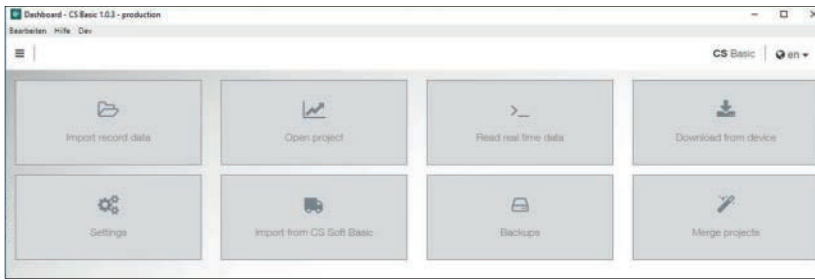

Intuitive operation

All important functions can be retrieved via the dashboard.

- Global Settings: Adjust units and change decimal places, store company name and logo
- Import real-time data: Establish Ethernet connection to CS logger or sensor. Trace real-time measured data in graphic and in table form
- Import from CS Soft Basic: Data migration from the previous version of CS Soft Basic
- Data backup: Backup of the projects and the database



Graphic evaluation

All measurement curves are indicated in terms of color. All necessary functions like free zoom, selection/deselection of single measured curves, free selection of periods, scaling of the axes, selection of colors and so on are integrated: This view can be stored as pdf file and sent by e-mail. Different data can be merged to one common file.

Date	Device	A2.1 Pressure A2a bar	B3.1 Dewpoint DewPoint °Ctd	B3.2 Rel.Humid. %	B3.3 Temperatur °C
27.01.17 13:52:18	0	9,6749	-50,6462	0,1534	20,2556
27.01.17 13:52:28	0	9,676	-51,4187	0,1394	20,2517
27.01.17 13:52:38	0	9,6769	-52,0952	0,128	20,2499
27.01.17 13:52:48	0	9,678	-52,791	0,1173	20,2479

Table view

All measuring points are listed with the exact time interval. The desired measuring channels with the measuring site name can be selected via the diagram explorer.

Channel	Average	Minimum	Date of minimum	Maximum	Date of maximum
A2.1 Pressure - A2a (bar)	9.6519 bar	9.61 bar	13.02.17 13:29:48	9.8361 bar	13.02.17 13:23:08
B3.2 Dewpoint - Rel.Humid. (%)	0.1094 %	0.0895 %	13.02.17 14:40:28	0.4118 %	13.02.17 14:30:08
B3.1 Dewpoint - DewPoint (°Ctd)	-53.2764 °Ctd	-57.9552 °Ctd	27.01.17 13:54:38	-41.6251 °Ctd	13.02.17 14:38:08

Statistics

All necessary statistics data are apparent at a glance. So the user can quickly see which minimum or maximum measured values occurred at which time and for how long.

	January	February	March	April	May	June	July	August	September	October	November	December	Sum
A1.2 Verbrauch Halle 1 - A1b (m³)	1,958,827	2,076,325	2,215,062	2,368,484	2,514,612	2,666,480	2,826,483	3,002,938	3,169,484	3,318,642	3,491,661	3,659,617	34,525,774
Consumption (m³)	117,498	138,737	153,402	148,148	151,869	160,003	176,455	166,546	149,158	173,019	187,956	116,356	1,817,148
Cost (€)	2,232.48	2,636.00	2,914.84	2,776.81	2,885.49	3,040.66	3,352.65	3,164.37	2,834.00	3,287.36	3,191.16	2,210.76	34,525,774
A1.1 Verbrauch Halle 1 - A1a (m³/h)	0	0	0	0	0	0	0	0	0	0	0	0	0
Average (m³/h)	157.6	205.98	205.8	202.54	203.52	221.66	236.5	223.25	206.67	232.19	232.67	155.99	
Maximum (m³/h)	1,000.36	527.02	736.39	1,154	662.43	616.27	617.9	636.36	931.66	642.96	669.77	2,410.71	

Flow evaluation

The software carries out flow analysis for all connected flow sensors optionally as daily, weekly or monthly report.

CS Network

Energy monitoring for compressed air and gases in an enterprise

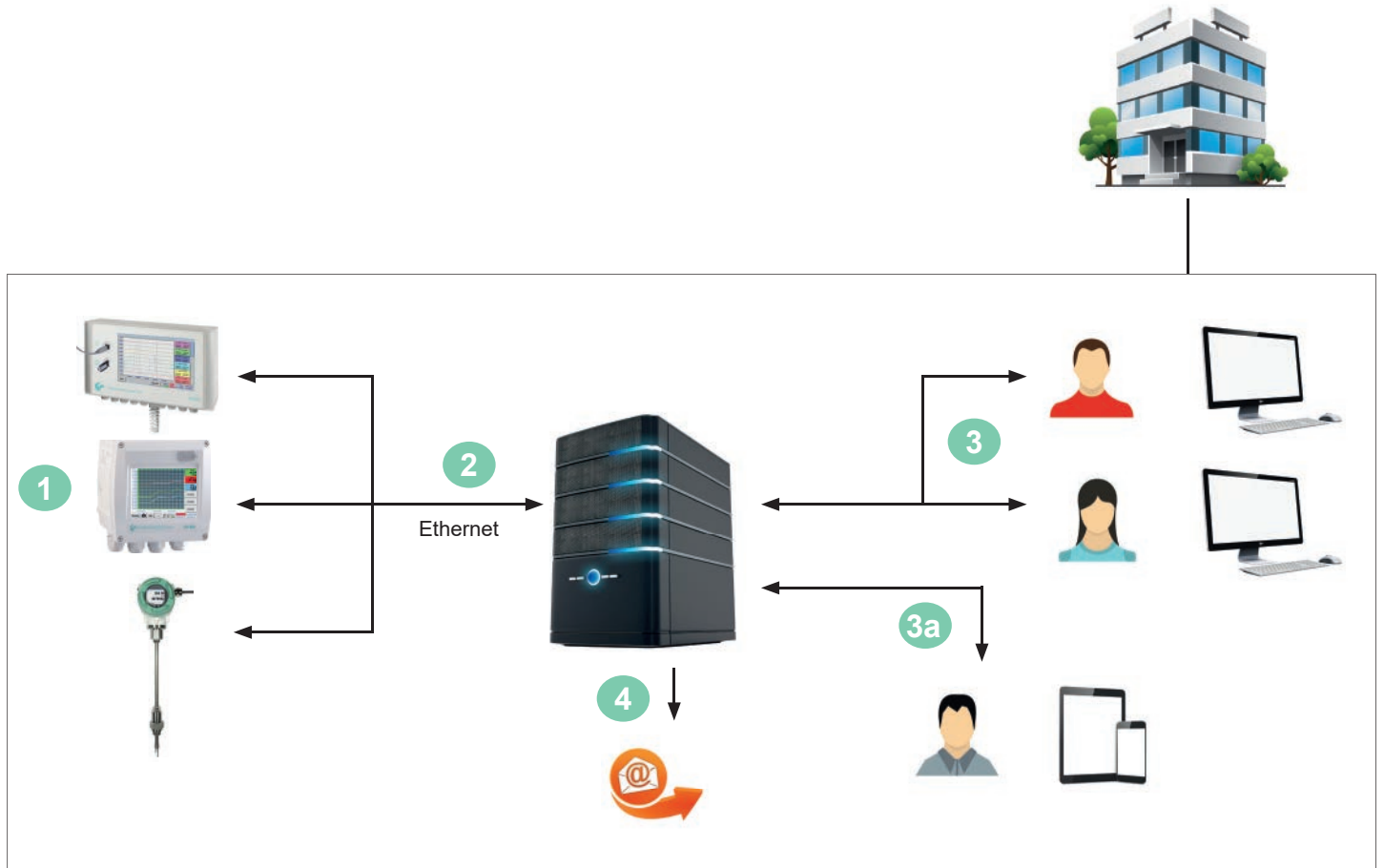

- 1 Single sensors with Ethernet interface or chart recorders with several sensors measure the compressed air and gas consumption of all departments/cost centers in an enterprise.
- 2 The CS Network (Server Installation) automatically collects the measured values of all CS chart recorders and CS sensors which are connected to the computer network in an enterprise and stores them in a database.
- 3 The evaluation/analysis of the measured data is effected via the evaluation software (Client) at an unlimited number of working places.
- 3a The evaluation software (Client) is browser-based and provides the user quick access to the measured data via tablet or smart-phone.
- 4 In case of an exceeding of the limit values (freely adjustable) there will be an automatic alarm via e-mail

CS Network

Energy monitoring for compressed air and gases in an enterprise



Graphic display with zoom function:

- Selection of the measured data to be indicated
- Easy zoom in and zoom out
- Up to 8 y-axes
- Quick access to daily/weekly/monthly view

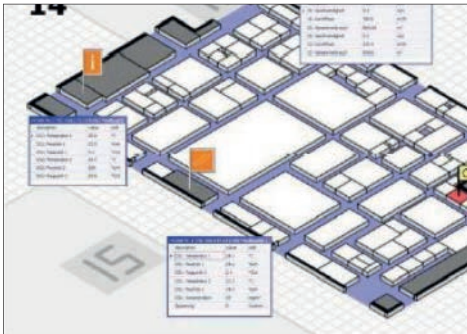

View: Current measured values

- Load background image
- Place/fix measured values screen
- Red measured values in case of alarm exceeding
- Quick access to measured value history

		January	February		November	December	Total
A1.2 consumption on hall 1 – A1b (m³)	From (m³)	1.958.827	2.076.325		3.491.661	3.659.617	
	To (m³)	2.076.325	2.215.062		3.659.617	3.775.973	
	Consumption (m³)	117.498	138.737		167.956	116.356	1.817.146
	Costs (€)	2.232,46	2.636,00		3.191,16	2.210,76	34.525,774

DESCRIPTION	ORDER-NR.
CS Network – energy monitoring with client/server solution (Max. 20 measured values of different sensors/devices)	0554 8041
CS Network – energy monitoring with client/server solution (Max. 50 measured values of different sensors/devices)	0554 8042
CS Network – energy monitoring with client/server solution (Max. 100 measured values of different sensors/devices)	0554 8043
CS Network – energy monitoring with client/server solution (Max. 200 measured values of different sensors/devices)	0554 8044
Module «Formula Editor» - with the formula editor, the measured values and constants can be calculated together (addition, subtraction, division, multiplication, root function, exponentiation)	Z554 8010
Module „Cockpit Function“ – By means of the Cockpit Function you can issue your personal background layout for the online values	on request
Module „Automatic Consumption Evaluation“ is e-mailed to a distribution list at the end of the month	on request
Module „Bar Chart, Pie Chart“ for annual comparison	on request



DS 52 - Digital process meter

In wall housing for 0 (4)...20 mA signals



With the digital process meter DS 52 in a shapely wall housing the annoying search and the mounting into a suitable plastic housing is no longer necessary. DS 52 disposes of 2 potential-free alarm contacts (switch-over contacts) which can be charged with maximum 230 VAC, 3 A. The alarm limits can be adjusted via the keys.

The display is supplied with 230 VAC and disposes of an internal mains unit which provides a voltage of 24 VDC/100 mA for the sensor. Free screwing clamps are available for forwarding the (0) 4...20 mA signal to superordinate systems.



Special features:

- Integrated in a shapely wall housing
- Suitable for all common sensors with 0 (4)...20 mA signal
- Easy operation
- 2 relay outputs (230 VAC, 3 A)

Example of use:

Pressure monitoring with optional alarm unit (buzzer + continuous light)

Example of use:

Temperature monitoring with alarm

DESCRIPTION	ORDER-NR.
DS 52 LED display in wall housing	0500 0009
Options:	
Supply 24 VDC instead of 230 VAC	Z500 0001
Supply 110 VAC instead of 230 VAC	Z500 0002
Alarm unit mounted at wall housing	Z500 0003
Alarm unit for external mounting	Z500 0004
All-in-one sets:	
DS 52 - all-in-one set for pressure monitoring/ alerting, consisting of DS 52 LED display and pressure sensor 0...16 bar	on request
DS 52 - all-in-one set for temperature monitoring/ alerting, consisting of DS 52 LED display and screw-in temperature probe -50...+500°C	on request

TECHNICAL DATA DS 52	
Dimensions:	118 x 133 x 92 mm (WxHxD)
Display:	LED, 5 digits, height 13 mm, 2 LED for alarm
Keypad:	4 keys: Enter, Back, Up, Down
Sensor input:	For sensors with 0(4)...20 mA signal. Connectable in 2-/3-4-wire technology
Accuracy:	max. +/- 20 µA, typical +/- 10 µA
Burden:	100 Ω
Sensor supply:	24 VDC, max. 100 mA
Voltage supply: (option)	230 VAC, 50/60 Hz (24 VDC or 110 VAC)
Outputs:	2 x relay output, changeover contact, 250 VAC, max. 3A
Alarm limits:	Freely adjustable via keypad
Hysteresis:	Freely adjustable via keypad
Operation temp.:	-10...+60 °C (storage temp.: -20...+80 °C)
Operation menu:	Lockable by code against third-party access



Competitive differential pressure probe for testing the filter performance

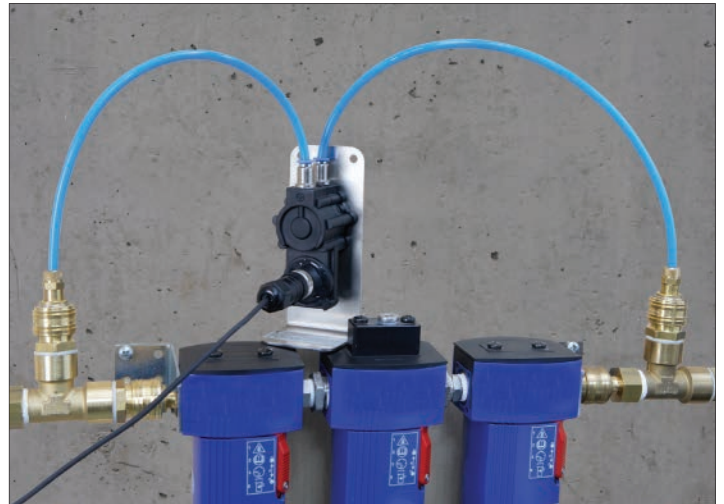

Typical operation of the differential pressure sensor: Connection with two PE hoses before and after the filter element.

Advantages at hand:

- Timely replacement of the filter elements
- At a differential pressure of >350 mbar at the latest, the filter elements should be replaced (active carbon filters are excluded from this)

DESCRIPTION	ORDER-NO.
Differential Pressure Sensor 1.6 bar diff	0694 3561
Connection cable for sensors 5 m with open ends	0553 0108
Connection cable for sensors 10 m with open ends	0553 0109
Connection cable for pressure, temperature or external sensors on mobile instruments, ODU / open ends, 5 m	0553 0501
Connection cable for pressure, temperature, or external sensors on mobile instruments, ODU / open ends, 10 m	0553 0502

TECHNICAL DATA	
Meas. range:	0 ... 1.6 bar differential pressure
Max. system pressure:	10 bar
Max. overload capability two-way:	15 bar
Max. overload capability one-way:	
+ page	15 bar
- page	10 bar
Bursting pressure:	60 bar
Total error:	2.0 % of full scale
Output:	4 ... 20 mA two-wire
Power supply:	10 ... 30 Vdc output 4 ... 20 mA
Operating temperature ambient:	-20 ... +80 °C
Process connections:	2× G 1/8 inner thread including plug-in coupling for 6-mm hose
Electrical connection:	Round plug M12 × 1

The longer a filter element is in use the dirtier it gets, hence, increasing the differential pressure. This has a direct impact on its performance and the energy loss – see diagram below.



Abb.: Typical differential pressure process, energy costs in relation fo filter element

PI 500 Set for mobile measurement

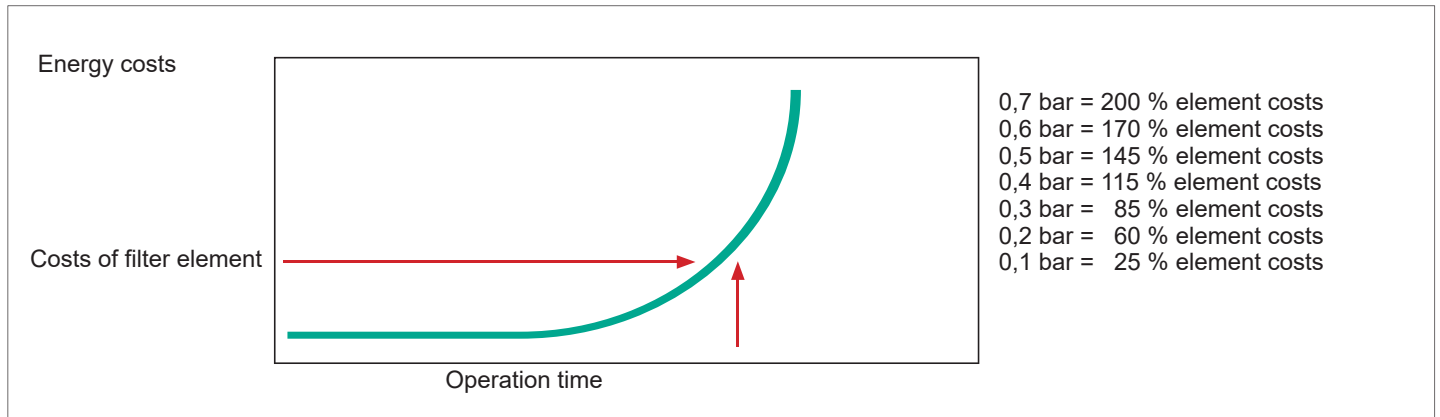

1. PI 500 portable measuring instruments with integrated data logger	0560 0511
2. Different pressure Sensor 1.6 bar diff.	0694 3561
3. Connection cable for pressure, temperature or external sensors on mobile instruments, ODU / open ends, 5 m	0553 0501

DS 52 Set for stationary measurement



1. DS 52 LED-display in wall housing	0500 0009
2. Different pressure sensor 1.6 bar diff.	0694 3561
3. Connection cable for sensors 5 m, with open ends	0553 0108



Notes



Notes



Headquarters Germany



Sales / Technology

SALES OFFICE SOUTH

CS INSTRUMENTS GmbH & Co. KG

Zindelsteiner Straße 15
78052 VS-Tannheim
Germany

Phone.: +49 (0) 7705 978 99-0
Fax: +49 (0) 7705 978 99-20

E-Mail: info@cs-instruments.com
Web.: www.cs-instruments.com/de

Order processing and re-calibration

SALES OFFICE NORTH

CS INSTRUMENTS GmbH & Co. KG

Am Oxer 28 c
24955 Harrislee
Germany

Phone.: +49 (0) 461 807 150-0
Fax: +49 (0) 461 807 150-15

E-Mail: info@cs-instruments.com
Web.: www.cs-instruments.com/de

Subsidiaries of CS INSTRUMENTS



FRANCE

CS INSTRUMENTS

4, rue du docteur Heulin
75017 Paris
France

Phone: +33 1 86 95 87 60

E-Mail: info@cs-instruments.fr

Web.: www.cs-instruments.com/fr



ITALY

CS INSTRUMENTS Italia S.r.l.

Via Matteotti 66
20092 - Cinisello Balsamo (Mi)
Italy

Phone: +39 0225061761

E-Mail: info@cs-instruments.it

Web.: www.cs-instruments.com/it



NETHERLANDS

CS INSTRUMENTS BENELUX BV

Korhoenweg 15
4791 RM Klundert
Netherlands

Phone: +31 (0)168 382 699

E-Mail: info@cs-instruments.nl

Web.: www.cs-instruments.com/nl



ÖSTERREICH

CS INSTRUMENTS GmbH

Kinostraße 21
4580 Windischgarsten
Österreich

Tel.: +49 (0) 7705 978 99-0

E-Mail: info@cs-instruments.com

Web.: www.cs-instruments.com/de



SWITZERLAND

CS INSTRUMENTS (Schweiz) GmbH

Mühlegasse 8
3237 Brüttelen
Switzerland

Phone: +41 32 355 4160

E-Mail: info@cs-instruments.ch

Web.: www.cs-instruments.com/ch



SPAIN

CS INSTRUMENTS, S.L.

Avda. Cerro Milano 4, Local 1
28051 Madrid
Spain

Phone: +34 91 33 15 758

E-Mail: info@cs-instruments-spain.es

Web.: www.cs-instruments-spain.com/es



SOUTH AFRICA

CS INSTRUMENTS (Pty) Ltd.

142 Briza Road, Table View
7441 Cape Town
South Africa

Phone: +27 (0) 21 557 56 18

E-Mail: info@cs-instruments.co.za

Web.: www.cs-instruments.com/za



SALES PARTNER USA

SIGA Developments LLC

5460 33rd. Street SE
Grand Rapids, MI 49512
USA

Phone.: +1 616 828 1024

E-Mail: sales@sigacas.com

Web.: www.sigacas.com



PolyAir Engineering Sàrl
Champ Cheval 2
CH - 1530 Payerne

+41 26 520 75 00
info@polyair.ch
www.polyair.ch